



FiberWood CLADDING

INSTALLATION GUIDE



Elevate Your Outdoor Experience.

Elevate your living experience with Fiberwood Cladding. Explore our range of four captivating aesthetic editions and innovative features, meticulously designed to harmonize with any architectural style. Embrace the full potential of your outdoor space with outstanding ease of maintenance and unparalleled durability that will endure for years to come.

Table of Contents

1. What is Fiberwood Cladding	p. 4
2. General Guidelines	p. 4
3. Safety Information	p. 5
4. Static	p. 5
5. Storage and Handling	p. 5
6. Environment Considerations	p. 5
7. Fire & Heat Exposition	p. 5
8. Technical Drawings	p. 6-8
9. Tools and Equipment	p. 9
10. Aesthetic (design & layout)	p. 9
11. General State of the Wall	p. 10
12. Basic Principle for Installing Cladding	p. 11
13. Before you Begin Installation	p. 11
14. First Step	p. 11
15. Fastening System	p. 11
16. Cladding Installation	p. 12
17. Preparing the Bottom of Walls and the Starter Course	p. 13
18. Subsequent Courses	p. 14-15
19. End Joints	p. 15
20. Vertical Cladding Installation	p. 15
21. Care, Maintenance and Safety Instructions	p. 16-17

CLADDING

CLASSIC – ROYAL – IMPERIAL – BOARD & BATTEN EDITIONS



1. What is Fiberwood Cladding

Fiberwood cladding is made from a mixture that consists of 60% hardwood dust, 30% from recycled clear plastics, 10% additives, pigments for the colors, and finally a protective envelope made of High Density Polyethylene (HDPE). Ninety percent of these products are made from recycled materials and are entirely recyclable making them environmentally friendly.

2. General Guidelines

Before you start any building, remodeling or renovation project, you should be aware and conform to municipal requirements and comply with all applicable building codes. Further, you should also have all necessary permits and obtain all certifications regarding your plans prior to starting any projects with our Fiberwood materials. Consumers and purchasers are solely responsible for the use that they make of these products. Local authorities often require plans, landscaping, implementation, design, structures, elevations... We would take this opportunity for aesthetic considerations and layouts.



3. Safety Information

Make certain that your job site is kept clean and free of obstacles at all times. We do not condone the use of faulty tools that could jeopardize your health and safety or that of anyone that has to be present on your job site. Ensure that you are taking every step necessary towards safety. For example eye and hearing protection, high-visibility clothing and garments, respiratory protection, gloves and approved safety footwear, etc.

4. Static

In dry or windy environments, there may be a temporary build-up of static electricity, which can vary depending on climate and site conditions. Additionally, heat pumps and dryer vents that are situated close to, or directed towards cladding can also generate static electricity on the material. Fortunately, this static charge can be easily removed by rinsing the affected area with water.

5. Storage and Handling

Fiberwood products should ideally be stored in a sheltered area in order to keep them in perfect condition. Keep your items away from direct sunlight and keep them covered until you are ready to install them. They should also be kept safe from debris and hazards. Boards should always be stored on a flat surface and off the ground in order to permit water to drain away. Materials are delivered on a pallet covered in a weatherproof shroud that needs to cover the products at all times. This protection should suffice in keeping your Fiberwood products in pristine condition.

6. Environmental Considerations

Even though Fiberwood cladding is fully recyclable, we recommend that you adopt an environmentally friendly code of conduct and practices. We suggest that you use dust collection systems for all your machine tools, that you manage debris and offcuts as well as all packaging, be cautious about delicate habitats and species.

7. Fire & Heat Exposition

Although Fiberwood cladding products are highly resistant to fire and heat sources, it remains a potential to become a source of combustion. It is impossible for us to assess every parameter in order to answer questions pertaining to "distance from" and "what temperature." For example, factors like ambient temperature, wind speed and direction, sun exposition and cloud coverage, source and intensity of heat points all have an impact. We recommend taking precautions accordingly: composites have a fire point and a melting point. Although highly resistant, composites can be deformed and defaced by excessive heat exposure.

Reflected sunlight from glass doors and windows could also negatively impact your Fiberwood cladding boards and products. This reflected light could even originate from a neighbor's property. We recommend that these heat sources be identified and evaluated before purchasing and installing our products.

8. Technical Drawings

ROYAL EDITION

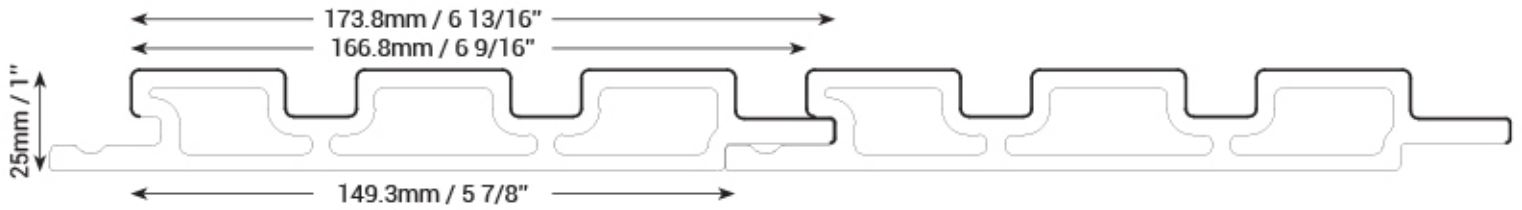

CLASSIC EDITION

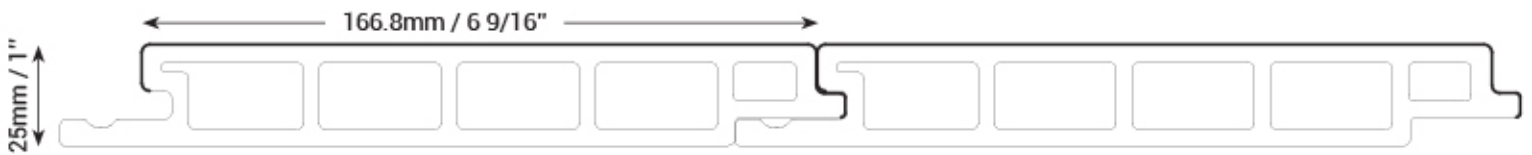

BOARD AND BATTEN EDITION

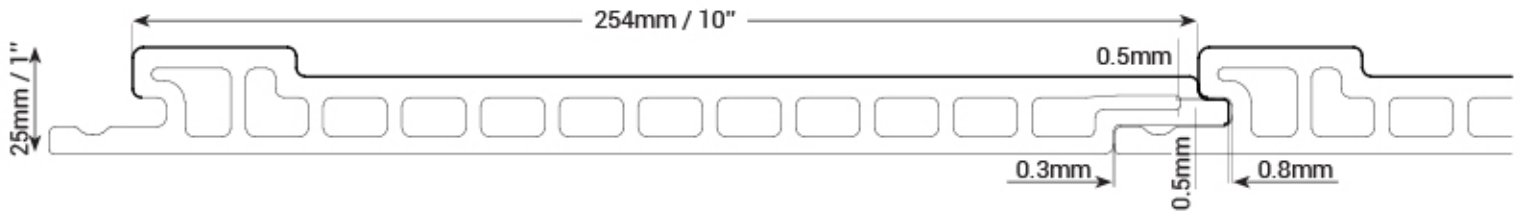

IMPERIAL EDITION

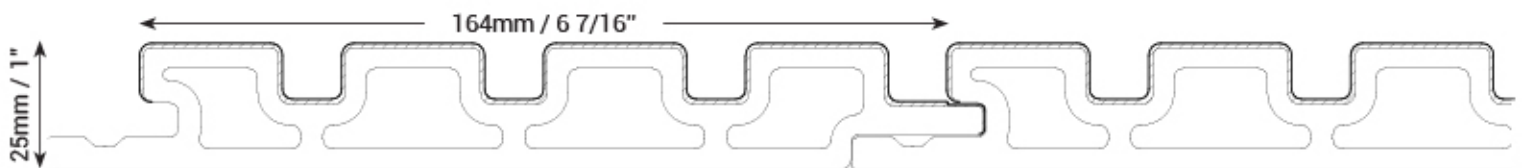

**EXTERNAL CORNER TRIM
BACK PART**

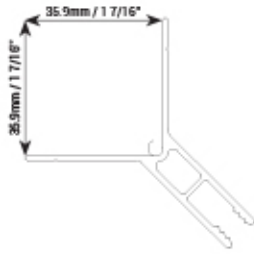

**INTERNAL CORNER TRIM
BACK PART**

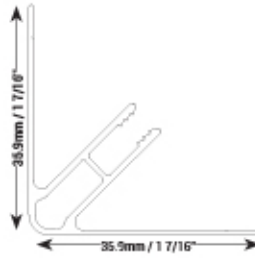

**H TRIM
BACK PART**

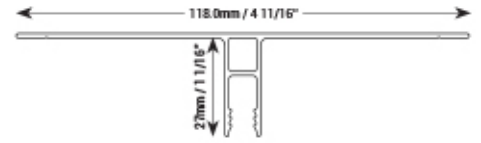

**EXTERNAL CORNER TRIM
FRONT PART**

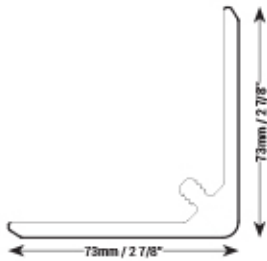

**INTERNAL CORNER TRIM
FRONT PART**

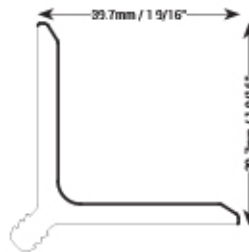

**H TRIM
FRONT PART**

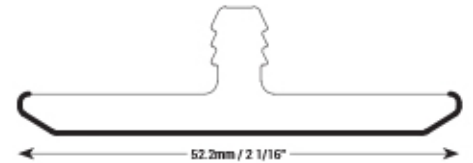

ASSEMBLED

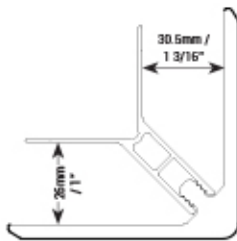

ASSEMBLED

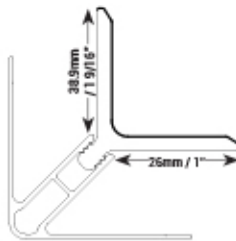

ASSEMBLED

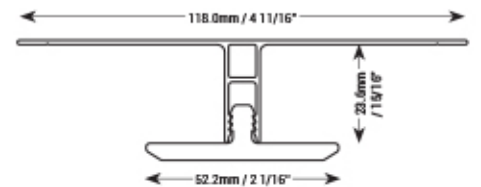

J TRIM - BACK PART



J TRIM - FRONT PART

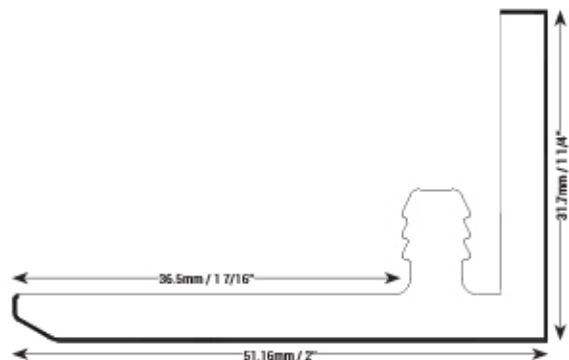

SINGLE STARTING TRIM - BACK PART

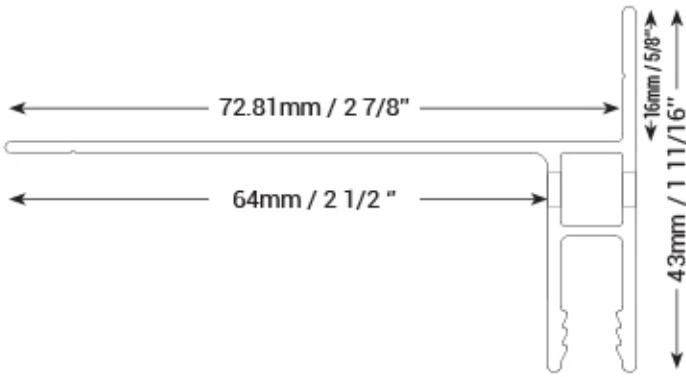

ASSEMBLED

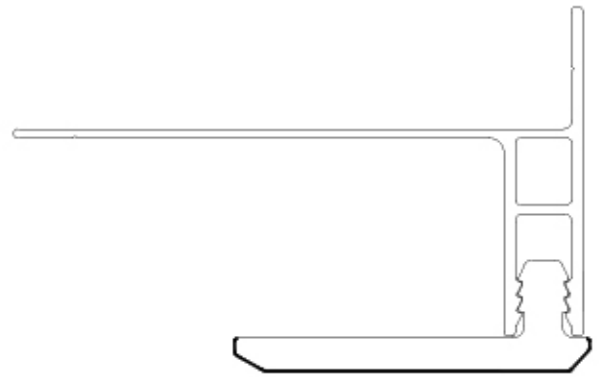

DOUBLE STARTING TRIM - BACK PART

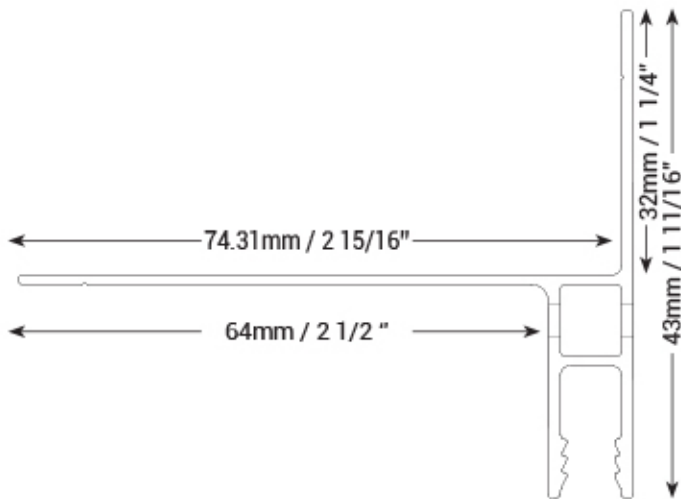

ASSEMBLED

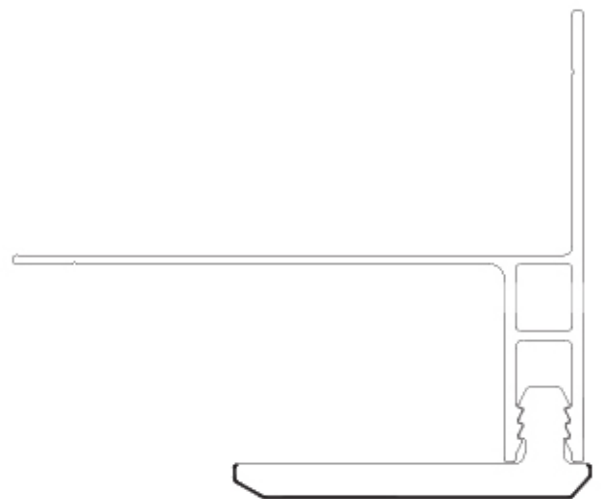

TRANSITION TRIM - FRONT PART

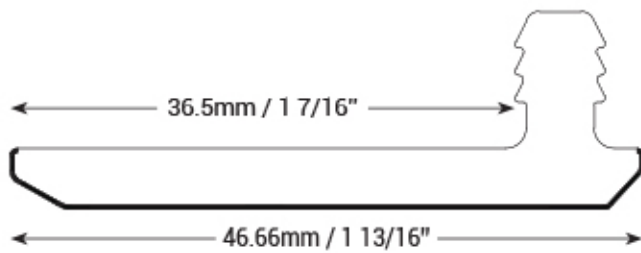

ASSEMBLED

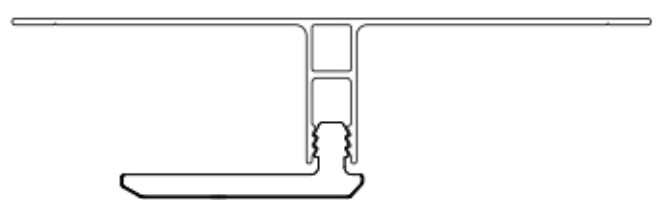

9. Tools and equipment

No specific or exclusive tools are necessary to cut or customize Fiberwood cladding products. Normal and conventional tools that carpenters utilize on a regular basis will be appropriate. Carbide tipped blades are recommended for your mechanized tools.

TOOLS:

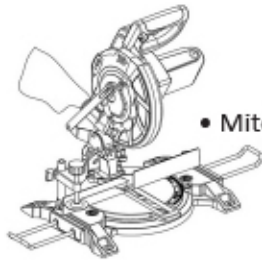

• Miter saw



• Blue chalk line*:

**To avoid staining the deck boards, only use blue carpenter's chalk.*

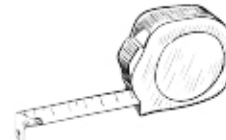

• Tape measure



• Hammer / Rubber mallet



• Eye protection



• Ear protection



• Drill & Impact Driver



• Spirit level & Laser level

DO NOT USE YOUR CLADDING BOARD AS A WORK BENCH.

It's important to keep your cladding free of excess dirt, dust, debris, pavers, and other building materials during construction. Using your cladding as a storage place for building materials risks permanent damage from sharp objects or accidental strikes.

10. Aesthetic (design & layout)

Plans and drawings are great tools at this stage. They are easy to modify and customize and they will give a clear picture of the desired outcome for whomever will make the project come to fruition. Fiberwood cladding products are all unique in their colors and variegations. Make a visual inventory of your lot and perhaps even a temporary layout ahead of your permanent installation.



11. General State of the Wall

Assess the wall and structure:

- Plumbness
- Level
- Square
- Plane
- Straight lines

Verify these points so that a decision is taken before anything is installed.

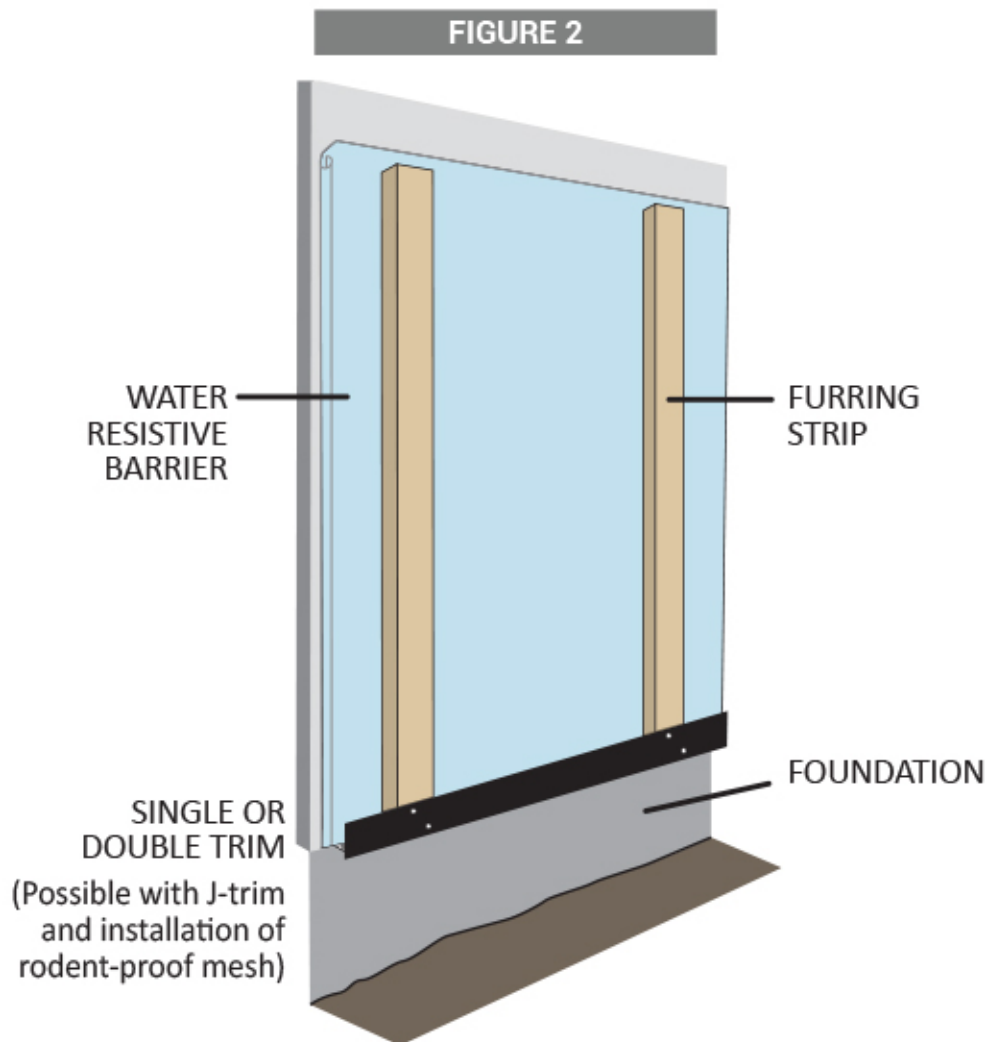

IMPORTANT : REFER TO THE COMPLET TECHNICAL DATA SHEET BEFORE STARTING THE INSTALLATION FOR FAMILIARIZE YOURSELF WITH FIBERWOOD PRODUCTS.

12. Basic Principles for Installing Cladding

Protecting the Integrity of the Cladding

- Correct fastening will result in a stable, long-lasting installation.
- The exterior cladding serves as the primary defense against the elements. Although highly effective, Fiberwood cladding is not waterproof.
- The building envelop should be inspected and completed before the cladding is installed.

13. Before you Begin Installation

Planning the Arrangement of the Boards

- The bundles are composed of 10 or 12 foot lengths. Refer to the label affixed to the pallet. This label identifies the product and the quantity of boards.
- Using boards of different lengths on the surface to be covered will minimize waste.

FIGURE 1

Avoid gaps. Plan before you cut.

Use transition molding and trim.

Maximum of 12' between transition trims.



NEVER INSTALL 2 BOARDS END-TO-END.

14. First Step

- Install your starter trim backer, inside and outside backers and all other necessary backers like the ones for windows and doors.

15. Fastening System

- Fiberwood siding is easily and quickly installed using our proprietary cladding screws. Fiberwood profiles include a fastening flange, which is concealed by the installation of subsequent rows.

IMPORTANT: COMPLIANCE WITH FIBERWOOD'S INSTALLATION, STORAGE AND MAINTENANCE REQUIREMENTS, AND WITH ALL APPLICABLE BUILDING CODES IS MANDATORY. PROBLEMS CAUSED BY FAILURE TO COMPLY WITH THESE REQUIREMENTS AND CODES MAY NOT BE COVERED BY THE APPLICABLE WARRANTIES.

16. Cladding Installation



All our boards can be installed both vertically and horizontally.

Installation of Furring Strips Vertically

All Fiberwood cladding profiles can be installed directly onto a rigid and structural substrate.

Furring Strip Specifications

- Do not use smaller than 1" x 3" furring strips. If the nailing substrate is not sufficient, use 2" x 3" studs.

Installation of Furring Strips

- Fiberwood cladding needs to be supported at a maximum spacing of 16" O/C.

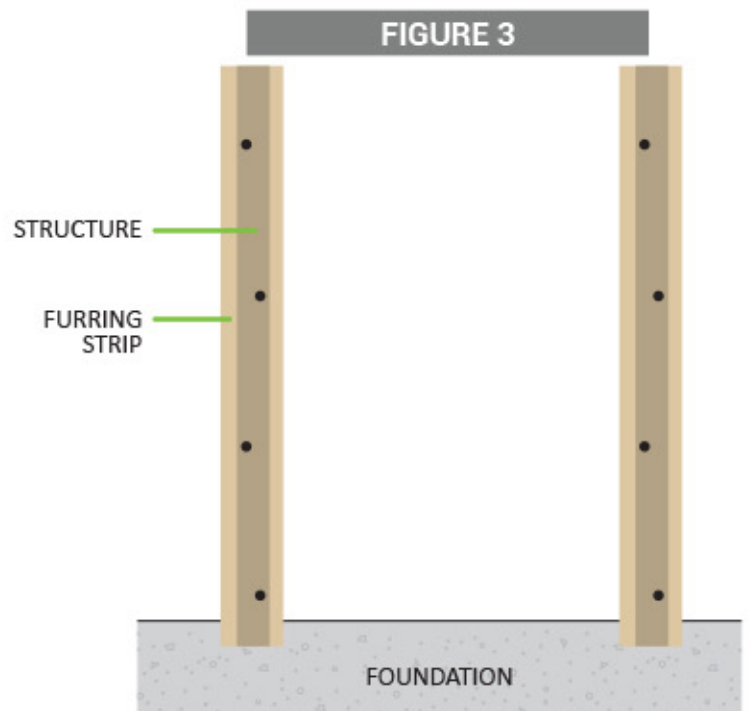

17. Preparing the Bottom of Walls and the Starter Course

Use one of the following trims for the starter course:

- **Single starter trim:** Starter course all around the building. Eliminates visible screws on the first row.[FIGURE 5]
- **Double starter trim:** Use the universal band if furring strips exceed 3/4" in thickness or if insulation panels are used. The ventilated band will cover the furring or insulation panels while preventing potential rodents and certain insects from getting in behind the siding.

Install the ventilated strip with a precision (laser) level or other type of level directly over the furring strips. The bottom of the furring strips should reach to the bottom of the ventilated strip. Secure with 2 screws horizontally every 16".

If a ventilated strip other than the ventilated single or double starter strip is used, the bottom of the first course of siding must extend at least 1/4" but no more than 1" past the bottom of the furring strip to allow for adequate water drainage.

FIGURE 4

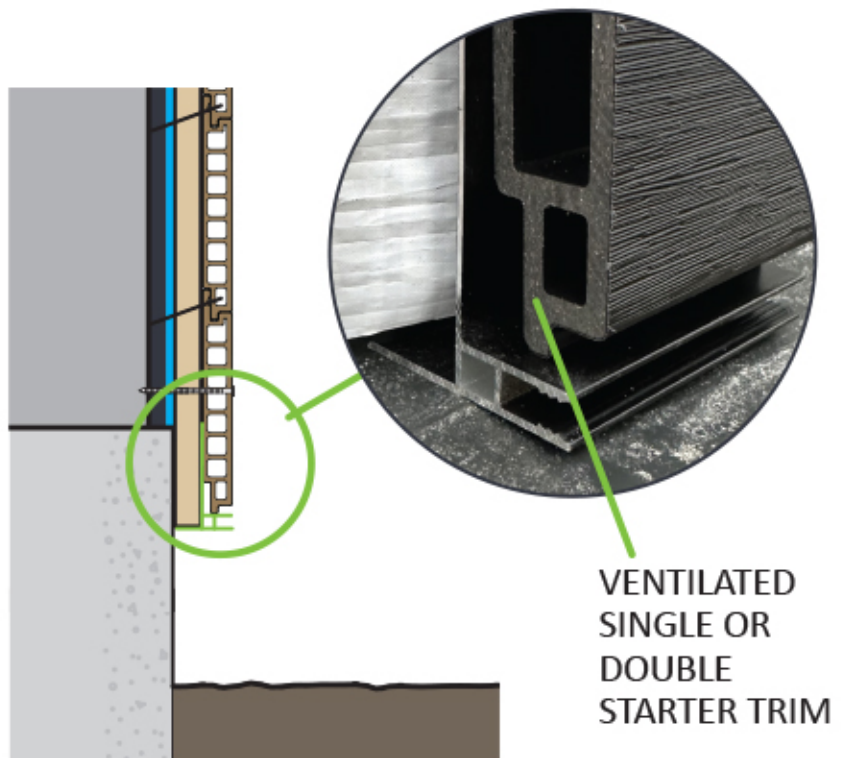
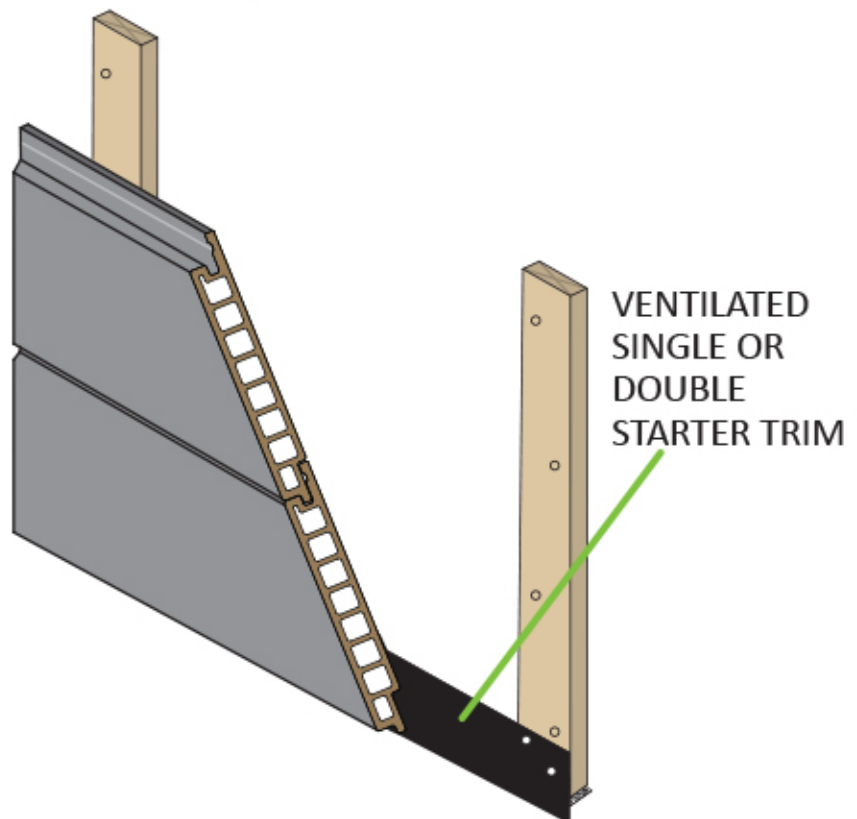

FIGURE 5



18. Subsequent Courses

It is important to install all rear parts according to the following drawings:



- 1 J-Trim
- 2 J-Starter Trim
- 3 J-Double Starter Trim
- 4 Transition Trim – Vertical installation
- 5 H-Trim – Horizontal installation
- 6 External Corner Trim
- 7 Internal Corner Trim



- Tighten the boards together lengthwise, with a maximum gap of 3/16" between the rear part of the vertical or horizontal transition trims. [FIGURE 6]
- Two screws centred on each furring strip.
- The upper alignment of boards can be adjusted up to a maximum of 1/16", taking care not to leave any visible screws. [FIGURE 7]
- If an adjustment of more than 1/16" is required, nail the bottom of the board.

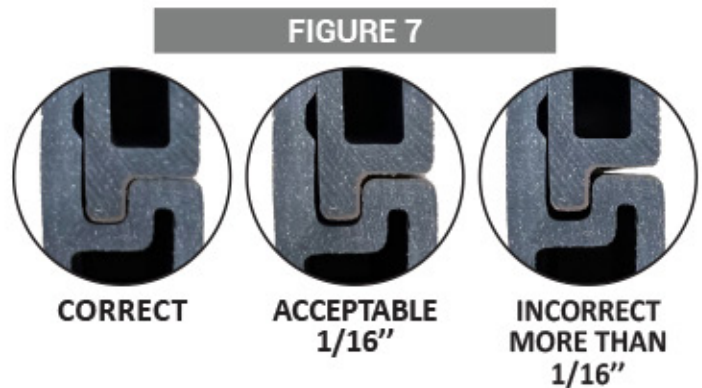
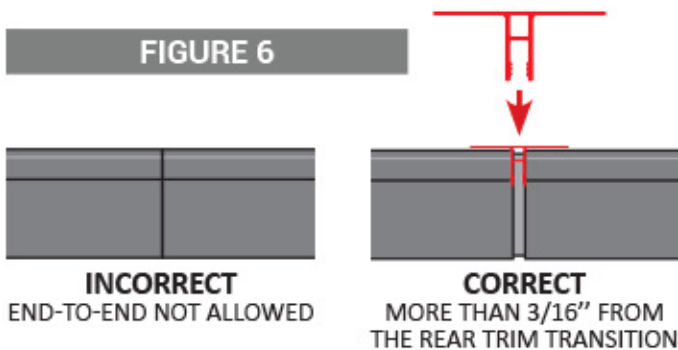

18. Subsequent Courses (ctdn)

TIPS

- For improved hammering without damaging the tenons or tongues, use a siding block of standard height and a length of 6' to 8'. [FIGURES 8 AND 9]
- ① Verify course alignment with a level every 3rd or 4th row and adjust the board as needed. A variance of 1/16" in height between boards is considered normal (3). [FIGURES 7]
- Using a reference line 3/4 from the top of the wall, place screws every 8 feet so that you can take measurements that will allow you to periodically verify alignment and make slight adjustments as needed.
- ② Align the rear part of the trims, one after the other, and ensure that they are all at the same level.

FIGURE 8

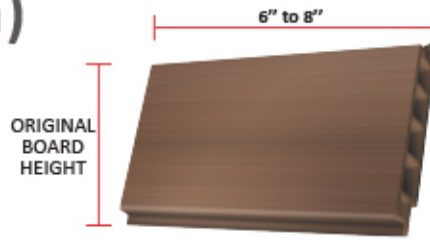
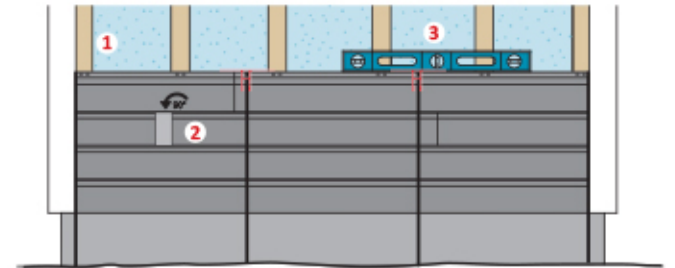

FIGURE 9



A TRANSITION TRIM MUST BE INSTALLED EVERY 12 FEET MAXIMUM, BOTH VERTICALLY AND HORIZONTALLY.

19. End Joints – NOT GUARANTEED

BOARD

- If you have to make a joint cut, make 22.5° cuts at the ends of both boards to be butted, apply touch-up stain as recommended. No sealant is required. [FIGURE 10]
- Cuts at 22.5 degrees must always be screwed onto a batten.

FIGURE 10

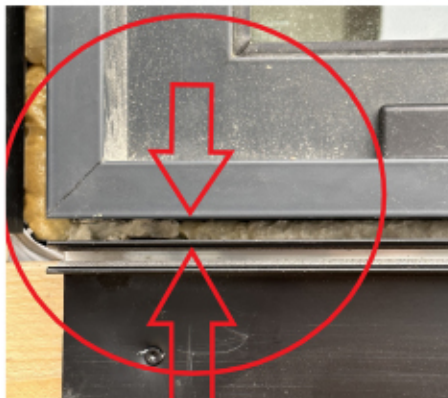

IMPORTANT

J TRIM: MINIMUM REQUIRED SPACE OF 3/16".



STARTER AND TRANSITION TRIMS FOR A FINISHING INSTALLATION IN BETWEEN ANOTHER TYPE OF CLADDING: MINIMUM SPACE OF 1/16".

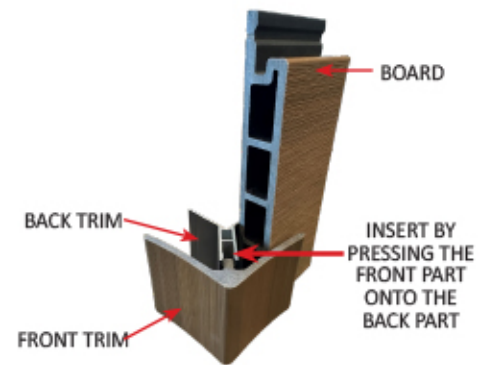

ONCE ALL THE BACK PARTS AND CLADDING BOARDS ARE IN PLACE, YOU WILL ONLY NEED TO INSTALL THE FRONT SECTIONS OF THE COMPOSITE TRIMS TO THE BACK PART BY INSERTING THEM INTO EACH OTHER TO SECURELY FASTEN THEM TOGETHER.

20. Vertical Cladding Installation

ALL THE FIBERWOOD PROFILES CAN BE INSTALLED VERTICALLY:

- ROYAL , IMPERIAL, CLASSIC, BOARD & BATTEN

A vertical installation may result in some visible screws. For this reason, be sure to fit the interlocking boards firmly together.

21. Care, Maintenance and Safety Instructions

FOR COMPOSITE CO-EXTRUSION CAPPED CLADDING

VENTILATION

To maintain optimal drainage plane performance, it is important to periodically inspect all horizontal and vertical gaps for debris. Additionally, any issues caused by ice or windblown snow should be addressed promptly.

CLEAN YOUR SIDING

To keep your cladding in good condition, it is recommended to clean it as needed, with a recommended frequency of twice per year. A soft bristle brush or blower can often be more effective than a hose for removing organic materials. For general cleaning, use soap and water or mild household cleaners.

DIRT AND GRIME

To remove accumulated dirt from your cladding, you can use a blower to dislodge it. If the dirt is stubborn, you can use soap and water along with a soft bristle brush to scrub it away.

SPECIAL CONSIDERATIONS

OIL AND GREASE STAINS

As a preventive measure against potential staining, it is important to always avoid contact with grease and oil. If grease or oil spills occur, it is necessary to clean them as soon as possible and at the latest within seven days. If soapy water is not effective in removing grease and oil stains, recommended all-purpose cleaners, including for composite, can be used to cut through the grease and dirt without discoloration.

CONSTRUCTION CHALK

Most construction chinks are designed to withstand cleaning. To avoid any difficulties, it is recommended to test chalk for ease of removal before using it. If chalk lines or stains persist even after attempting to remove them, it is best to contact the chalk manufacturer for specific cleaning instructions.

MASONRY CONSTRUCTION

To prevent any damage to the cladding during and after construction, it is crucial to protect it from masonry, mortar, and grout dust. These materials have electrostatic properties that can result in a white or hazy residue deposit on the cladding surface. Efflorescence, a phenomenon where minerals are leached out of stone, grout, and masonry materials, can also leave mineral deposits behind after water evaporates. To minimize these effects during masonry construction, it is important to keep materials dry and allow masonry and cement to cure properly. One way to prevent this is by completely and securely covering the cladding surface area during the construction phase or installing the cladding after the masonry construction phase.

In certain arid and mountainous environments, minerals from the soil can also cause a hazy effect when deposited on the cladding surface. When mineral particulate is deposited through windblown minerals or leaching, more frequent periodic cleaning may be necessary to maintain the visual attractiveness of the cladding.

MOLD AND MILDEW

Mold and mildew growth occurs due to common environmental conditions. Mold spores are tiny and lightweight, easily traveling through the air and being deposited on surfaces where, under favorable conditions, they establish colonies on decaying organic materials such as windblown pollen and landscaping debris.

Climate conditions vary by region, and in areas where ideal mold colonization conditions exist, such as high pollen counts and humidity or where mold and mildew have already colonized other inorganic surfaces, more frequent cleaning may be necessary. To control or prevent mold growth, it is recommended to proactively remove organic materials that provide a food source for mold development. You can use a garden hose and warm water with a soft-bristled brush to remove both organic matter and mold.

If mold is present, there are many commercial products available for cleaning. Make sure the product can be used on composite, then follow the manufacturer's instructions and use cleaners within their indicated shelf life. It is not recommended to mix different cleaning products together, as harmful chemical reactions could occur. Additionally, it is important to never mix bleach and acids.



829, Industriel Blvd., Bois-des-Filion, QC, J6Z 4T3
514-360-1866 / 888-360-1866
fiberwood.ca