

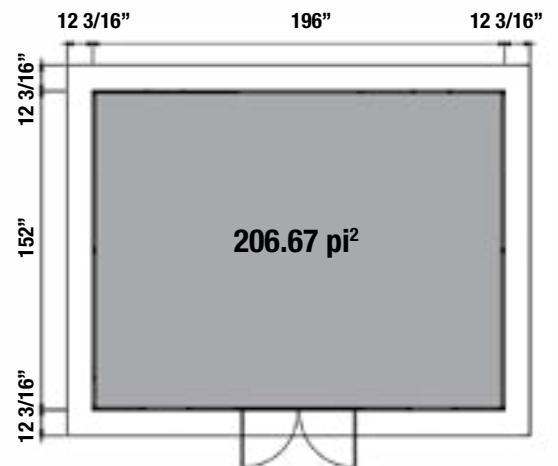

INSTALLATION INSTRUCTIONS  
INSTRUCTIONS D'INSTALLATION





## INSTALLATION INSTRUCTIONS AND RECOMMENDATIONS

- Remove all parts from the packaging and lay them out on a clean work surface in Zone I/II and III.
- Please read the list of components BEFORE assembly, making sure that no parts are damaged or missing.
- In the unlikely event you receive defective materials, the product warranty does not cover labor. Once you alter a board (cut, rip, rout, screw, etc.) it cannot be returned.
- Assemble all parts according to the instructions published by Fiberwood and do not skip any steps. Since Fiberwood's limited warranty does not apply to all conditions attributable to improper shed installation.
- For shed construction and handling, please use only the tools listed in the assembly instructions.
- Always wear work gloves, safety glasses, and any other type of long-sleeved clothing during shed assembly or any type of maintenance work.
- Treat wall panels with extreme care before and during assembly. Place them carefully on the ground.
- Avoid walking on them or placing objects on them.
- At least two people are required to assemble the shed.
- Allow sufficient space at the installation site outside the shed to access it from the outside during assembly.
- Do not install in cold or windy weather. Wind direction is an important factor that must be considered when placing the shed on your property. Choose a suitable location where there are no excessive winds to prevent high wind pressure on the doors.
- Due to the high proportion of composite material, the surface may have different color shades. This does not mean that special treatment is required or that it will affect the shed's lifespan.
- You need to get a tube of 100% transparent silicone sealant.

## CARE, MAINTENANCE AND SAFETY INSTRUCTIONS











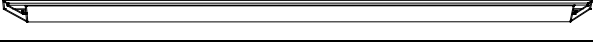

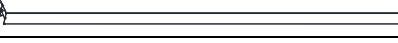
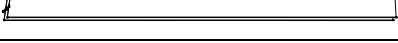

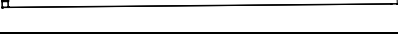
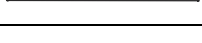
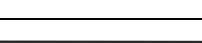
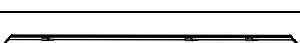

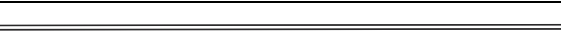
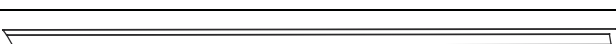
- ⚠ The shed is generally used for storing objects. The shed is not especially designed for residential purposes.
- ⚠ Regularly check the shed for stability and ensure that the shed location is level.
- ⚠ Be careful when handling parts with metal edges.
- ⚠ For the construction and handling of the shed, please only use tools that are listed in the assembly instructions.
- ⚠ Avoid using lawnmowers and mechanical scythe in the immediate vicinity of the shed.
- ⚠ To clean the shed, start by rinsing it with a garden hose to remove surface debris. Then you can use a soft-bristled brush with warm soapy water.
- ⚠ Do not damage, gouge, scrape or puncture any surface of the shed, using metal shovels or sharp-edge tools to remove snow and ice on any surface of the garden shed or in any other way. Instead, use a plastic shovel and recommended calcium chloride or rock salt to melt snow and ice.
- ⚠ Do not paint, stain or apply other coating materials or any other chemical substances, including detergents or pesticides to the shed.
- ⚠ Clean oil or grease spills as soon as possible and at the latest within seven days. Start by rinsing with a garden hose and use warm soapy water and a soft-bristled brush. If that's not enough, you can use recommended all-purpose cleaners, including for composite, and follow the manufacturer's instructions carefully.
- ⚠ Do not store any hot objects in the shed, such as recently used grills or blowtorches, or any volatile chemicals.
- ⚠ Do not lean heavy objects against the walls of the shed, as it could deform the entire structure.
- ⚠ Keep the roof free of snow and accumulated foliage. Large amounts of snow can damage the shed and make it dangerous for entering.
- ⚠ Ensure there is adequate ventilation in the shed to prevent excess moisture.
- ⚠ Always keep the doors closed and locked when the composite shed is not in use to avoid any kind of wind damage.
- ⚠ If there is mold present, you can use a garden hose and warm soapy water with a soft-bristled brush. If that's not enough, you can use recommended cleaners, including for mold, and follow the manufacturer's instructions carefully.
- ⚠ Avoid direct water projection from an automatic watering system onto the composite boards or other parts of the shed, as this water could cause stains where it hits the surface.

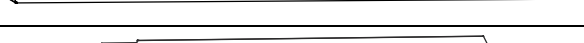
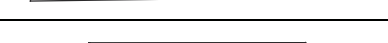
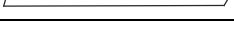





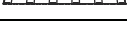
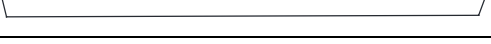





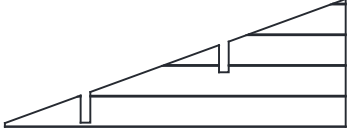









## INSTRUCTIONS ET RECOMMANDATIONS D'INSTALLATION











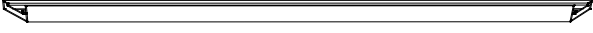



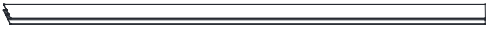
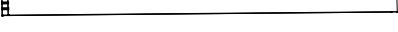
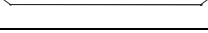

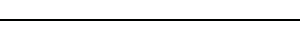
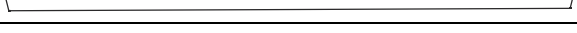
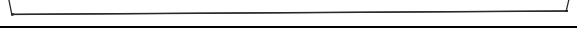

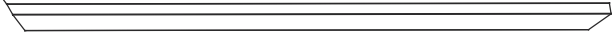

- Retirez toutes les pièces de l'emballage et étalez-les sur une surface de travail propre en zone I/II et III.
- Veuillez lire la liste des composantes AVANT l'assemblage, assurez-vous qu'aucune pièce n'est endommagée ou manquante.
- Dans le cas improbable où vous recevez des matériaux défectueux, notez que la garantie sur les produits ne couvre pas les frais de main-d'œuvre. Une fois que vous avez altéré le produit (p.ex., en le coupant, le refendant, le toupillant ou le vissant), vous ne pouvez plus le retourner.
- Assemblez toutes les pièces conformément aux instructions publiées par Fiberwood et ne sautez aucune étape. Étant donné que la garantie limitée de Fiberwood ne s'applique pas à toutes les conditions attribuables à une mauvaise installation du cabanon.
- Pour la construction et la manipulation du cabanon, veuillez utiliser uniquement les outils répertoriés dans les instructions de montage.
- Portez toujours des gants de travail, des lunettes de sécurité et tout autre type de vêtements à manches longues lors de l'assemblage du cabanon ou de tout type de travaux d'entretien.
- Traitez les panneaux muraux avec un soin extrême avant et pendant le montage. Placez-les soigneusement sur le sol.
- Évitez de marcher dessus ou de placer des objets dessus.
- Au moins deux personnes sont nécessaires pour assembler le cabanon.
- Laissez suffisamment d'espace sur le site d'installation à l'extérieur du cabanon pour pouvoir y accéder de l'extérieur lors de l'assemblage.
- Ne pas installer par temps froid ou venteux. La direction du vent est un facteur important qui doit être pris en compte lors de la mise en place du cabanon sur votre terrain. Choisissez un endroit adéquat là où il n'y aurait pas de vents excessifs afin d'éviter qu'il y ait une pression trop forte de vent élevé sur les portes.
- En raison de la forte proportion de matériel en composite, la surface peut avoir différentes nuances de couleur. Ceci ne signifie pas qu'un traitement spécial est nécessaire ou que cela affectera la durée de vie du cabanon.
- Vous devez vous procurer un tube de scellant 100% silicone transparent.













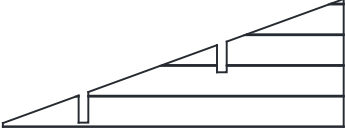









## INSTRUCTIONS D'UTILISATION, D'ENTRETIEN ET DE SÉCURITÉ

- ⚠ Le cabanon est généralement utilisé pour ranger des objets. Il n'est pas spécialement conçu à des fins résidentielles.
- ⚠ Vérifiez régulièrement la stabilité du cabanon et assurez-vous que l'emplacement du cabanon est de niveau.
- ⚠ Soyez prudent lorsque vous manipulez des pièces avec des bords en métal.
- ⚠ Évitez d'utiliser des tondeuses à gazon et des faux mécaniques à proximité immédiate du cabanon.
- ⚠ Pour nettoyer le cabanon, commencez par le rincer avec un boyau d'arrosage pour éliminer les débris de surface. Ensuite vous pouvez utiliser une brosse à poils souples avec de l'eau savonneuse tiède.
- ⚠ Ne pas endommager, entailler, gratter ou perforer toute surface du cabanon, en utilisant une pelle à métal ou des outils à bords tranchants pour enlever la neige ou de la glace sur toute surface de celui-ci, ou de toute autre manière. Utilisez plutôt une pelle en plastique et du chlorure de calcium ou du sel gemme recommandé pour faire fondre la neige et la glace.
- ⚠ N'appliquez pas de peinture, de teinture ou d'autres matériaux de revêtement ni toute substance chimique, y compris des nettoyeurs ou des pesticides sur le cabanon.
- ⚠ Nettoyez le plus rapidement possible et au plus tard dans les sept jours les taches laissées par des déversements d'huile ou de graisse. Commencez par rincer avec un boyau d'arrosage et utilisez de l'eau tiède savonneuse et une brosse à poils souples. Si cela n'est pas suffisant, vous pouvez utiliser des nettoyeurs recommandés tout usage, incluant pour le composite, et suivre attentivement les instructions du fabricant.
- ⚠ Ne rangez pas d'objets chauds dans le cabanon, tels que des grils ou des chalumeaux récemment utilisés, ou des produits chimiques volatils.
- ⚠ N'appuyez pas d'objets lourds contre les murs du cabanon, car cela pourrait déformer l'ensemble de celui-ci.
- ⚠ Gardez le toit exempt du surplus de neige et de feuillage accumulé. De grandes quantités de neige peuvent endommager le cabanon en composite et rendre son accès dangereux.
- ⚠ Assurez-vous qu'il y a une ventilation suffisante dans le cabanon afin d'éviter un excès d'humidité.
- ⚠ Gardez toujours les portes fermées et verrouillées lorsque le cabanon n'est pas utilisé pour éviter tout type de dommages causés par le vent.
- ⚠ Si de la moisissure est présente, vous pouvez utiliser un boyau d'arrosage et de l'eau tiède savonneuse, avec une brosse à poils souples. Si cela n'est pas suffisant, vous pouvez utiliser des nettoyeurs recommandés, incluant pour la moisissure, et suivre attentivement les instructions du fabricant.
- ⚠ Évitez la projection d'eau d'un système d'arrosage automatique directement sur les planches de composites ou les autres pièces du cabanon puisque cette eau peut occasionner des tâches là où elle frappe la surface.

Nº	STRUCTURE	DESCRIPTION	QTY	ZONE*
1		Aluminum bottom frame 1 9/16" H X 1 3/8" D X 196 3/8" L	1	A
2		Aluminum bottom frame 1 9/16" H X 1 3/8" D X 196 3/8" L	1	A
3		Aluminum bottom frame 1 9/16" H X 1 3/8" D X 152 5/16" L	2	A
4		Aluminum bottom column 2 3/8" H X 2 3/8" D X 84 3/4" L	2	A
5		Aluminum bottom column 2 3/8" H X 2 3/8" D X 84 3/4" L	2	A
6		Aluminum bottom column 2 3/8" H X 1 5/16" D X 109 1/4" L	4	A
7		Aluminum bottom column 2 3/8" H X 1 5/16" D X 83 3/4" L	2	A
8		Door frame (top) 2 1/2" H X 1 9/16" D X 58 7/16" L	1	A
9		Door frame (bottom) 2 1/2" H X 1 9/16" D X 58 7/16" L	1	A
10		Door frame (left) 2 1/2" H X 1 9/16" D X 79 1/8" L	1	A
11		Door frame (right) 2 1/2" H X 1 9/16" D X 79 1/8" L	1	A
12		Aluminum roof top beam 5 1/2" H X 1 9/16" D X 173 1/4" L	1	B
13		Aluminum roof beam 5 1/2" H X 1 9/16" D X 173 1/4" L	6	B
14		Aluminum roof outer frame 7 1/16" H X 1 9/16" D X 117 7/8" L	2	B
15		Aluminum roof outer frame 7 1/16" H X 1 9/16" D X 117 7/8" L	2	B
16		Aluminum roof outer frame (Left & Right) 5 1/2" H X 1 9/16" D X 176 3/8" L	2	B
17		Aluminum U profile 1 1/2" H X 1 3/16" D X 27 1/8" L	12	B
18		Aluminum U profile 1 1/2" H X 1 3/16" D X 16 3/16" L	4	B
19		Gutter for roof 5 1/4" H X 3 5/8" D X 177 3/16" L	1	B
20		Gutter for roof 5 1/4" H X 3 5/8" D X 177 3/16" L	1	B
21		Window kits 35 7/16" H X 23 5/8" D	2	A
22		Vent 19 11/16" H X 8 1/16" D	2	A
23		Door kit 78 3/4" H X 59 1/16" D	1	C
24		PVC roof panel 43 5/16" H X 1" D X 118 1/8" L	10	C
25		Ridge panel	5	C
26		Composite Wall Board 6 5/16" H X 1 1/8" D X 74 5/16" L	56	A
27		Composite Wall Board 6 5/16" H X 1 1/8" D X 66 7/16" L	42	A

N°	STRUCTURE	DESCRIPTION	QTY	ZONE*
28		Composite Wall Board 6 5/16" H X 1 1/8" D X 57 7/8" L	21	A
29		Composite Wall Board 6 5/16" H X 1 1/8" D X 22 9/16" L	24	A
30		Composite Wall Board 6 5/16" H X 1 1/8" D X 24 1/2" L	4	A
31		Composite Wall Panel 6 5/16" H X 1 1/8" D X 66 7/16" L	4	A
32		Composite Wall Panel 6 5/16" H X 1 1/8" D X 57 7/8" L	2	A
33		Decorative panel	2	C
A		Screw and Plastic Dowel #8 x 80mm	18	A
B		Screw #4 x 20mm	300	A
C		L bracket for column 2 9/16" H X 13/16" D X 2 9/16" L	20	A
D		Door connector	4	A
E		Door frame mounting	8	A
F		Hexagon key	1	A
G		L bracket for beam 1 9/16" H X 1 9/16" D X 1 9/16" L	46	B
H		L bracket for roof frame	4	B
I		Beam plug	2	B
J		Beam plug	12	B
K		Support bar	2	B
L		Screw for the roof #5 x 75mm	160	C
M		Rain cap for roof screw	160	C
N		Screw bits	1	C
O		Gutter cover	2	C
P		Gutter cover	2	C
Q		Roof plug	36	C
R		Door lock	1	C

N°	PIÈCES	DESCRIPTION	QTÉ	ZONE*
1		Cadre inférieur en aluminium 1 9/16" H X 1 3/8" D X 196 3/8" L	1	A
2		Cadre inférieur en aluminium 1 9/16" H X 1 3/8" D X 196 3/8" L	1	A
3		Colonne en aluminium 1 9/16" H X 1 3/8" D X 152 5/16" L	2	A
4		Colonne en aluminium 2 3/8" H X 2 3/8" D X 84 3/4" L	2	A
5		Cadre inférieur en aluminium 2 3/8" H X 2 3/8" D X 84 3/4" L	2	A
6		Cadre inférieur en aluminium 2 3/8" H X 1 5/16" D X 109 1/4" L	4	A
7		Cadre inférieur en aluminium 2 3/8" H X 1 5/16" D X 83 3/4" L	2	A
8		Cadre de porte haut 2 1/2" H X 1 9/16" D X 58 7/16" L	1	A
9		Cadre de porte bas 2 1/2" H X 1 9/16" D X 58 7/16" L	1	A
10		Cadre de porte gauche 2 1/2" H X 1 9/16" D X 79 1/8" L	1	A
11		Cadre de porte droit 2 1/2" H X 1 9/16" D X 79 1/8" L	1	A
12		Poutre de sommet de toit en aluminium 5 1/2" H X 1 9/16" D X 173 1/4" L	1	B
13		Poutre de toit en aluminium 5 1/2" H X 1 9/16" D X 173 1/4" L	6	B
14		Cadre extérieur de toit en aluminium 7 1/16" H X 1 9/16" D X 117 7/8" L	2	B
15		Cadre extérieur de toit en aluminium 7 1/16" H X 1 9/16" D X 117 7/8" L	2	B
16		Cadre extérieur de toit en aluminium (droite et gauche) 5 1/2" H X 1 9/16" D X 176 3/8" L	2	B
17		Profilé U en aluminium 1 1/2" H X 1 3/16" D X 27 1/8" L	12	B
18		Profilé U en aluminium 1 1/2" H X 1 3/16" D X 16 3/16" L	4	B
19		Gouttière de toit 5 1/4" H X 3 5/8" D X 177 3/16" L	1	B
20		Gouttière de toit 5 1/4" H X 3 5/8" D X 177 3/16" L	1	B
21		Fenêtre 35 7/16" H X 23 5/8" D	2	A
22		Ventilation 19 11/16" H X 8 1/16" D	2	A
23		Porte 78 3/4" H X 59 1/16" D	1	C
24		Panneau de toit en PVC 43 5/16" H X 1" D X 118 1/8" L	10	C
25		Faîtière	5	C
26		Planche murale en composite 6 5/16" H X 1 1/8" D X 74 5/16" L	56	A
27		Planche murale en composite 6 5/16" H X 1 1/8" D X 66 7/16" L	42	A

N°	PIÈCES	DESCRIPTION	QTÉ	ZONE*
28		Planche murale en composite 6 5/16" H X 1 1/8" D X 57 7/8" L	21	A
29		Planche murale en composite 6 5/16" H X 1 1/8" D X 22 9/16" L	24	A
30		Planche murale en composite 6 5/16" H X 1 1/8" D X 24 1/2" L	4	A
31		Panneau murale en composite 6 5/16" H X 1 1/8" D X 66 7/16" L	4	A
32		Panneau murale en composite 6 5/16" H X 1 1/8" D X 57 7/8" L	2	A
33		Décoration murale	2	C
A		Vis et cheville en plastique #8 x 80mm	18	A
B		Vis #4 x 20mm	300	A
C		Connecteur de colonne en L 2 9/16" H X 13/16" D X 2 9/16" L	20	A
D		Connecteur de porte	4	A
E		Cadre de porte	8	A
F		Clé Allen	1	A
G		Connecteur de poutre en L 1 9/16" H X 1 9/16" D X 1 9/16" L	46	B
H		Connecteur de cadre de toit en L	4	B
I		Serre-poutre	2	B
J		Serre-poutre	12	B
K		Rail de connexion	2	B
L		Vis pour le toit #5 x 75mm	160	C
M		Protection anti-pluie pour vis de toit	160	C
N		Embout pour visseuse	1	C
O		Embout de gouttière	2	C
P		Embout de gouttière	2	C
Q		Bouchon de toit	36	C
R		Poignée de porte	1	C



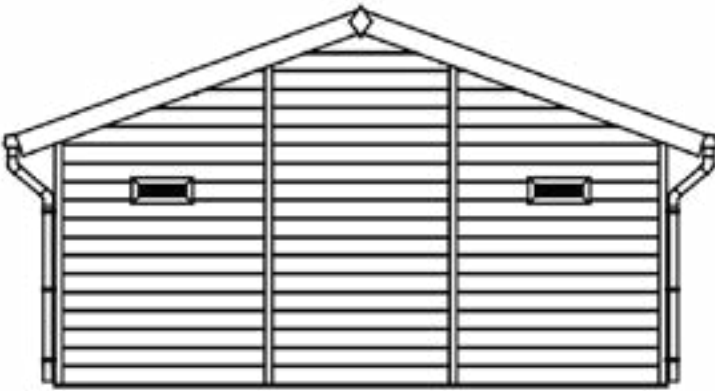

EN BACK VIEW  
FR VUE ARRIÈRE

FRONT VIEW  
VUE FRONTALE

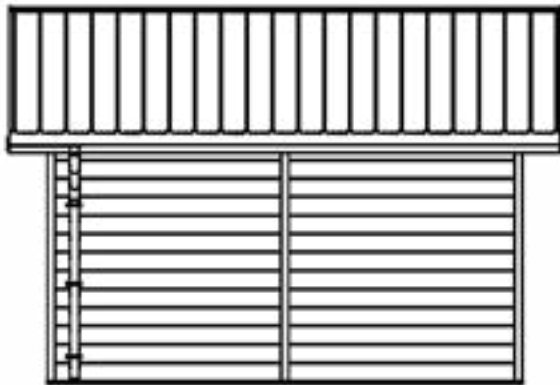

EN SIDE VIEW  
FR VUE LATÉRALE

AXONOMETRIC VIEW  
PERSPECTIVE

TOOLS REQUIRED FOR INSTALLATION  
OUTILS NÉCESSAIRES POUR L'INSTALLATION



## GROUND REQUIREMENTS PRÉ-REQUIS AU SOL

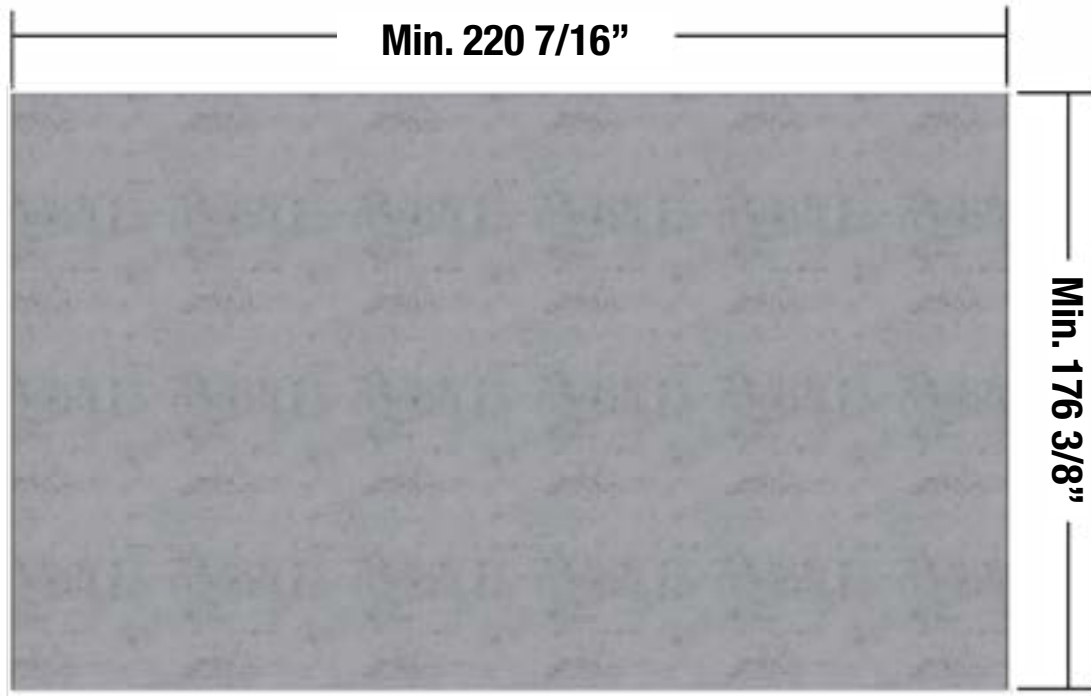

- 
- EN** Composite shed should be installed on the hard ground like concrete foundation, the surface of ground should be flat and the size should follow the dimension of drawing.
- 
- FR** Le cabanon en composite doit être installé sur un sol dur comme une fondation en béton, la surface du sol doit être plate et la taille doit suivre la dimension du dessin.

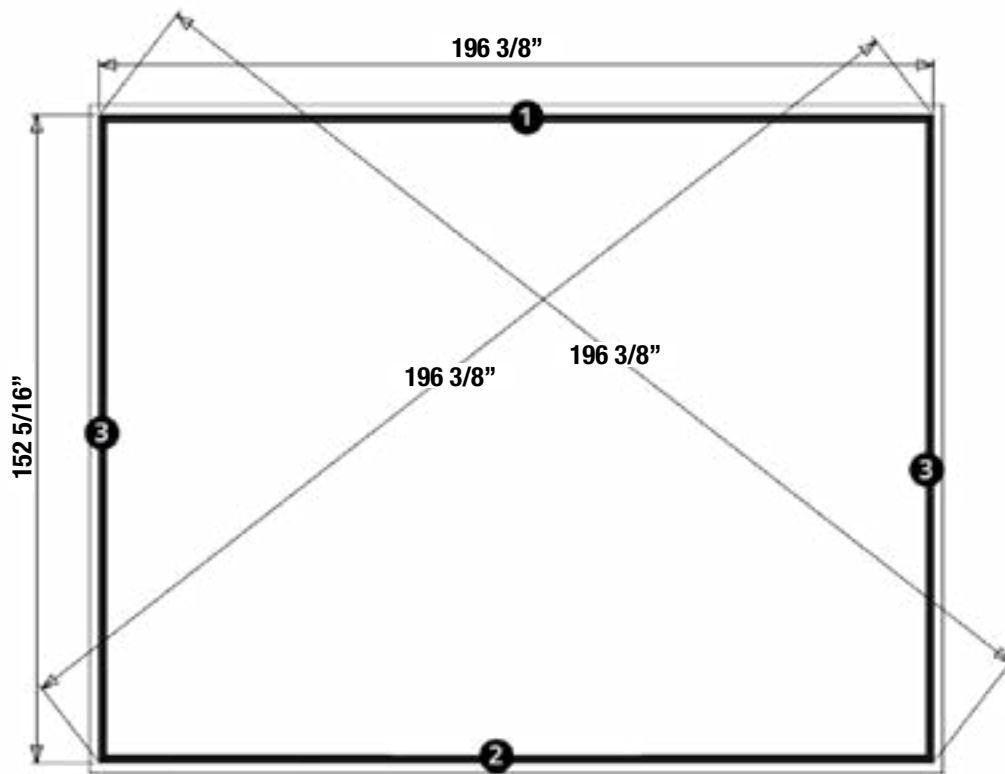

**EN** Frame out the installation area by using chalk. Check the leveling before starting the installation process – the foundation is key to guarantee the safety and the durability of your composite shed(s).

**FR** Définissez la zone d'installation à la craie. Une bonne fondation est très importante pour garantir la sécurité et la solidité de votre cabanon, vérifiez que celle-ci est bien plane.

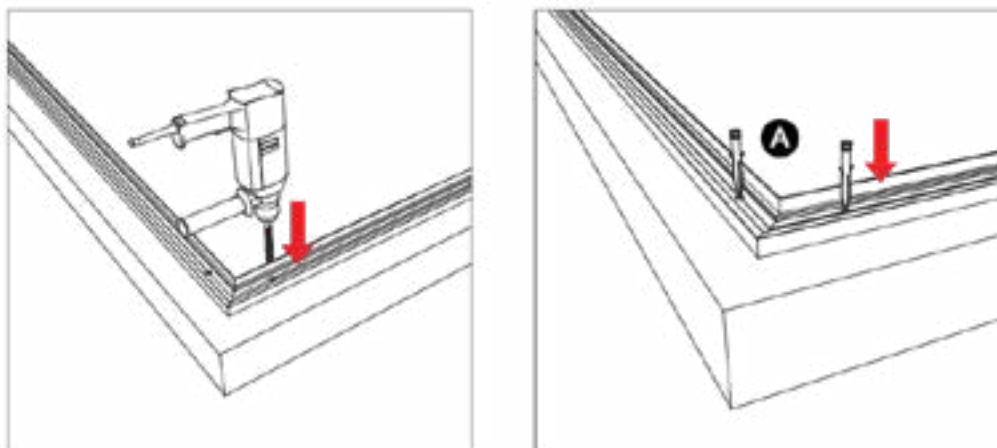

**EN** Place the (A)-screw that includes the plastic dowel in the holes and screw them into the ground as much as possible.

**FR** Placez les (A)-vis comprenant la cheville en plastique dans les trous et vissez dans le sol autant que possible.

# COLUMN POSITION VIEW POSITION DES COLONNES

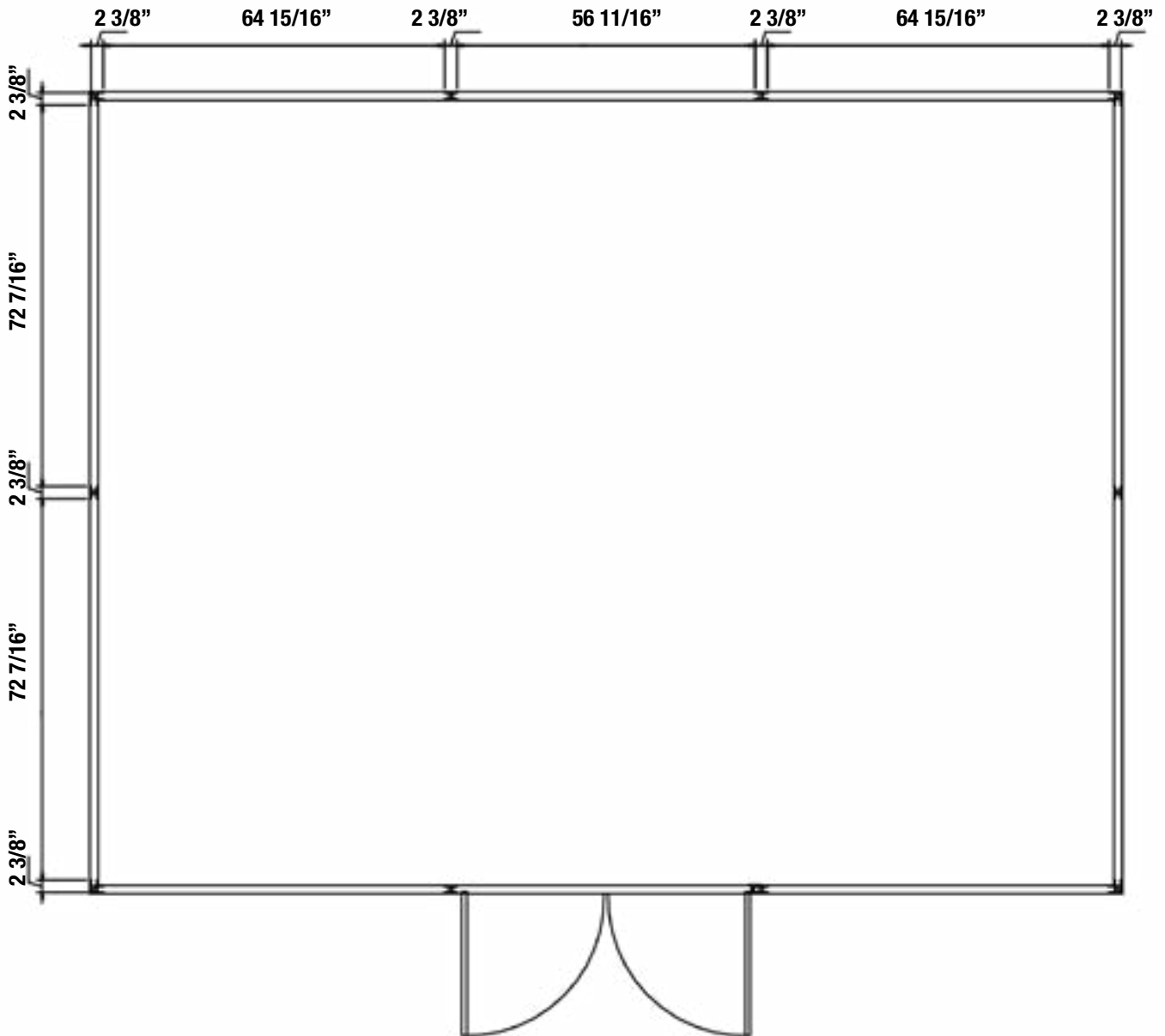

**EN** Respect the above spacing when installing the columns.

**FR** Veuillez respecter l'espace ci-dessus pour l'installation des colonnes.

EN Left rear column

FR Colonne arrière gauche

EN Left front column

FR Colonne avant gauche

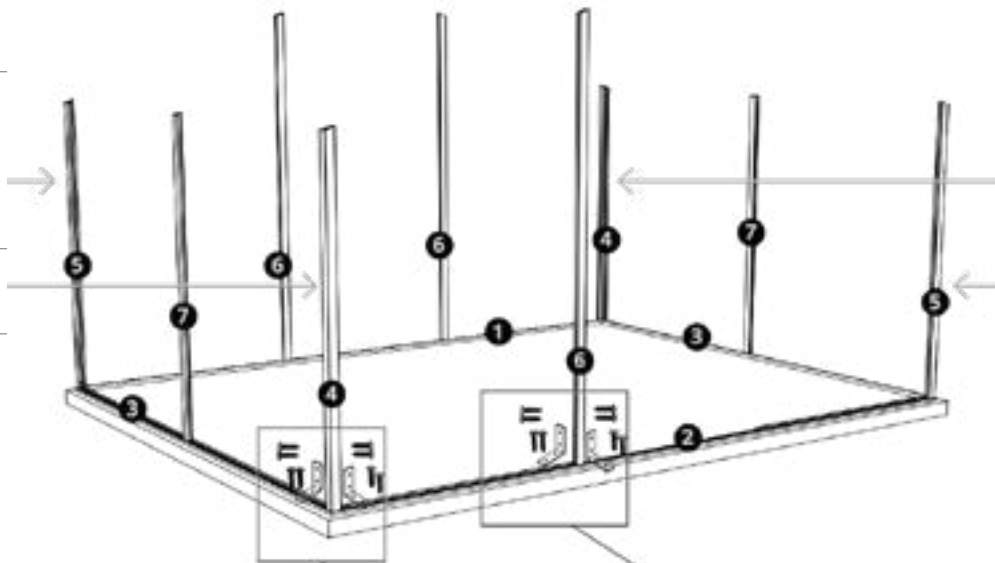

EN Right rear column

FR Colonne arrière droite

EN Right front column

FR Colonne avant droite

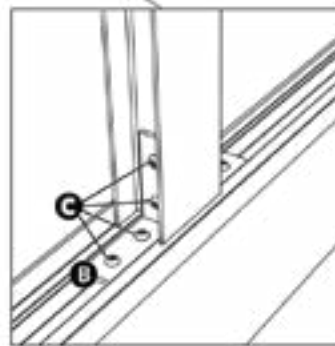
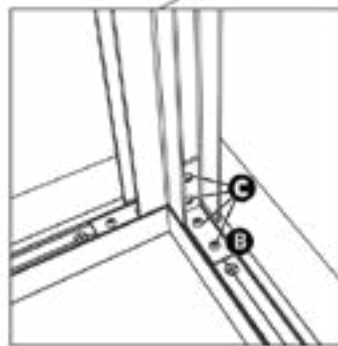

EN Install the columns to the right position and fix them with the L brackets and screws. **Make sure that they are placed vertically.**

FR Installez les colonnes dans le bon sens et fixez-les en vissant les connecteurs de colonnes en L et les vis. **Assurez-vous de leur verticalité.**

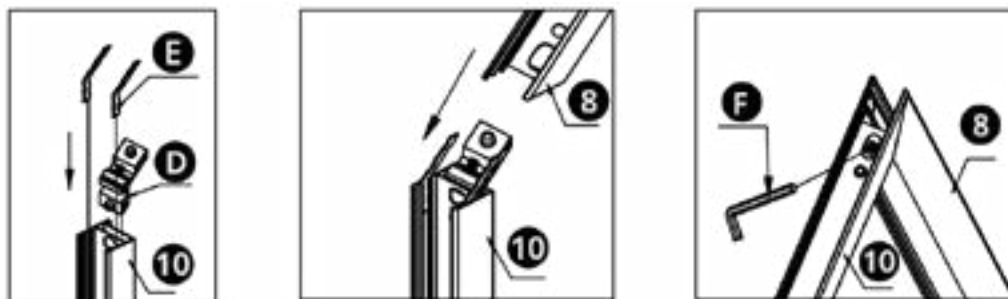

**EN** Assemble the door frame with connection acc. and fasten with hexagon key. **The hinges are in front of the frame.**

**FR** Assemblez le cadre de porte avec les connecteurs appropriés et serrez avec la clé hexagonale. **Les charnières se trouvent à l'avant du cadre.**

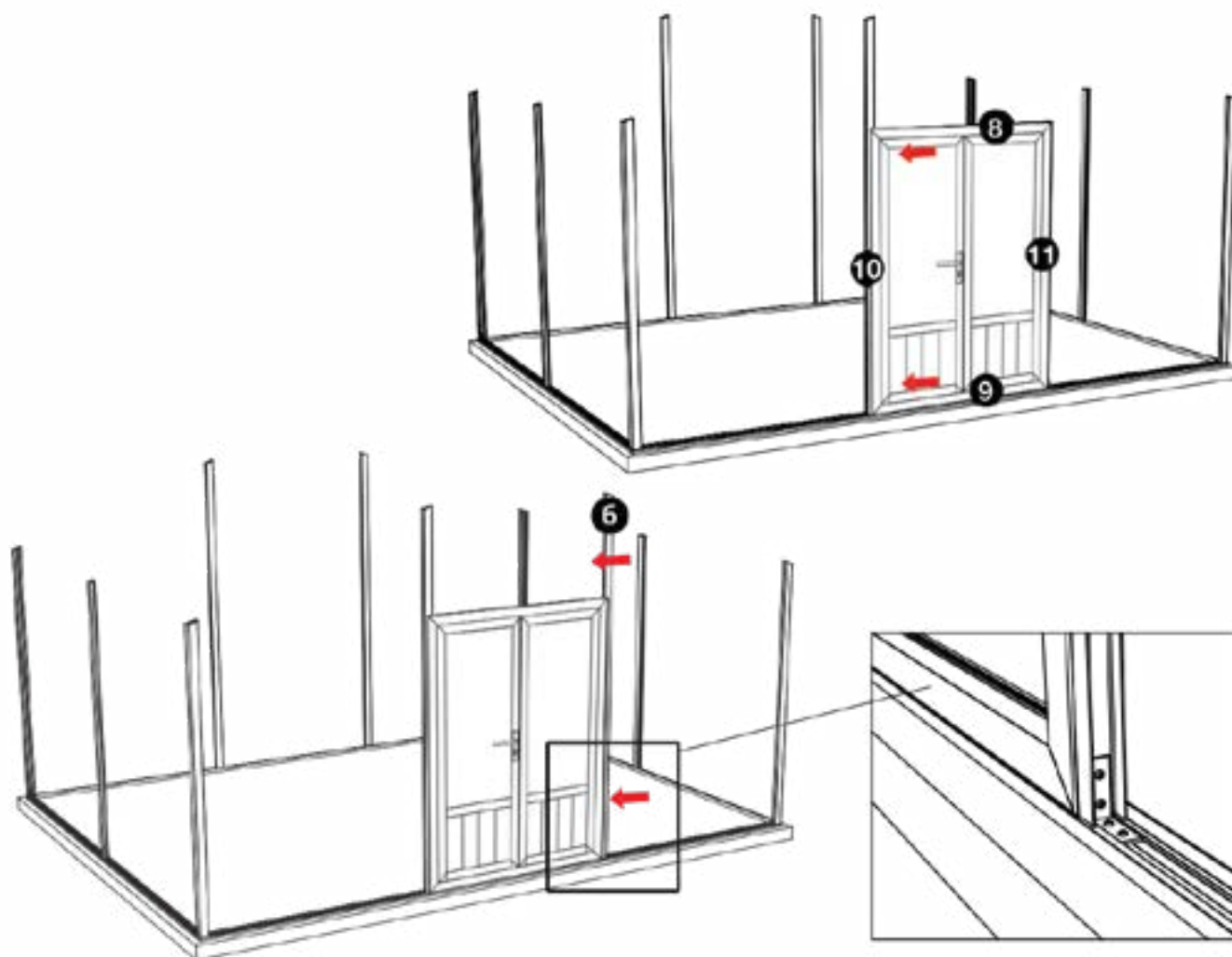

**EN** Insert the door frame to the aluminum bottom frame, fixing them with the L-shaped columns.

**FR** Insérez le cadre de porte dans le cadre inférieur en aluminium et fixez-les avec les colonnes en forme de L.

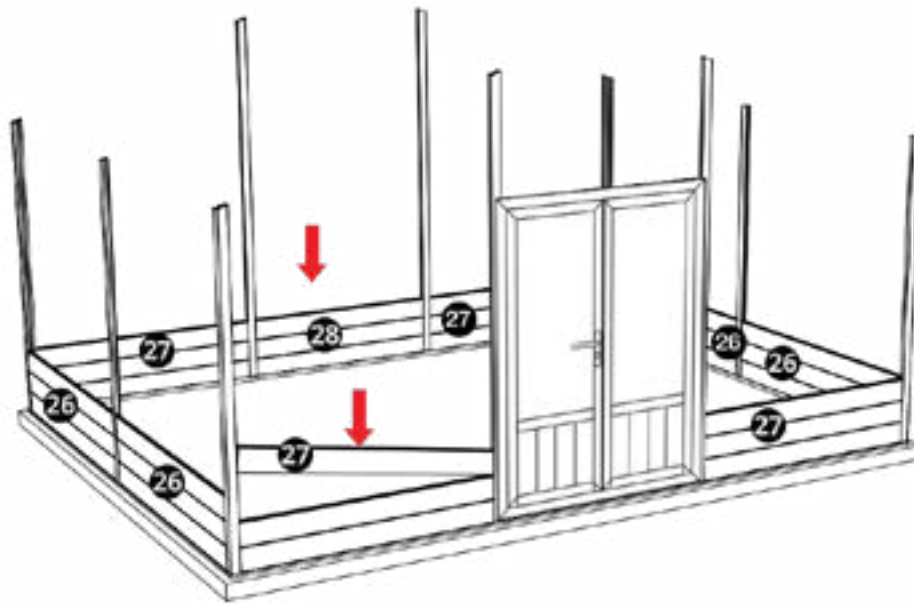

**EN** Install the wall board one by one. We suggest that you install them equally to each unit so that the whole frame becomes stable.

**FR** Installez la première ligne de planche murale sur chaque pan de mur et procédez de la même façon pour les autres.

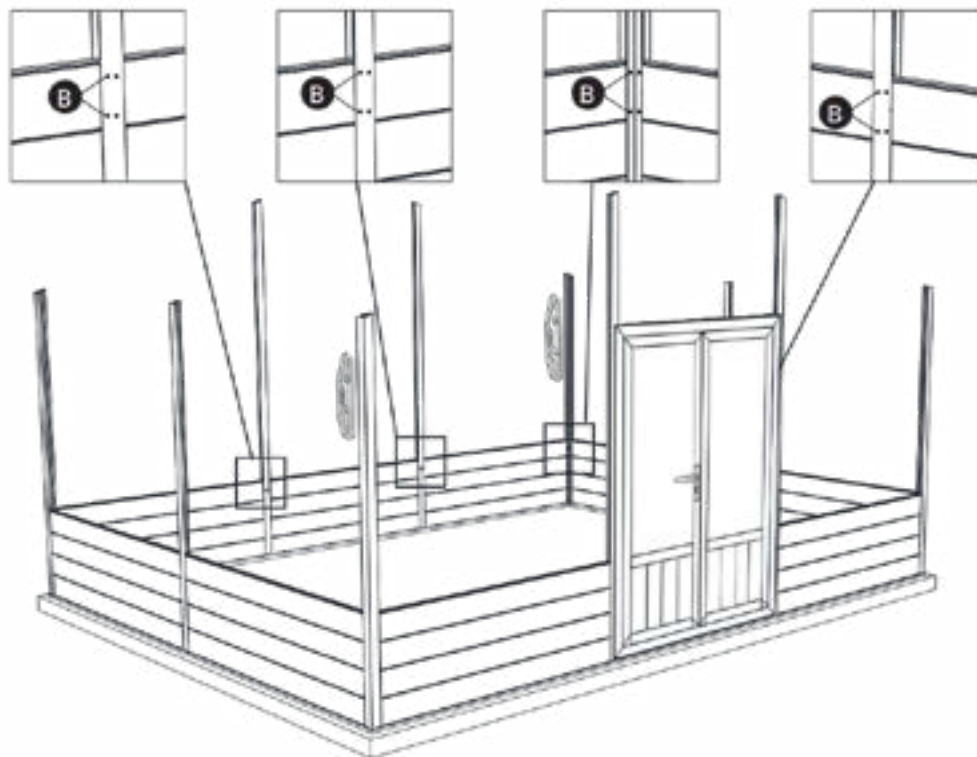

**EN** Screw through each column to the wall panel every 4 boards – making sure the columns are vertical.

**FR** Vissez chaque colonne à toutes les 4 planches murales – en vous assurant que les colonnes demeurent bien verticales.

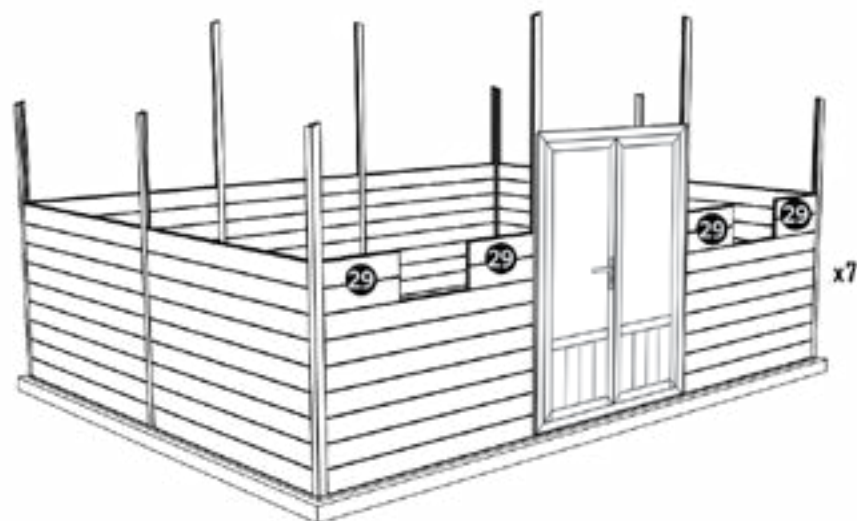

**EN** Install the wall panels according to the picture shown above.

**FR** Installez les planches murales comme illustré ci-dessus.

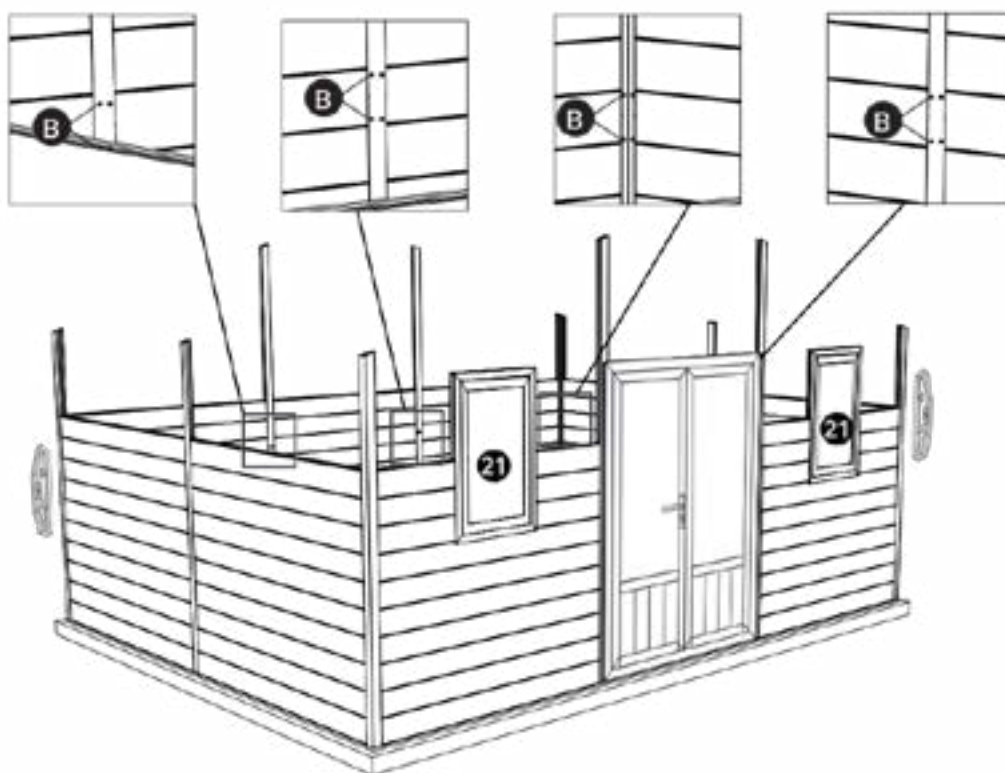

**EN** Screw through each column to the wall panel every 4 boards – making sure the columns are vertical. Then, install the window kits. **These are inward opening windows, make sure to not mistake the left from the right kits when installing them.**

**FR** Vissez chaque colonne à toutes les 4 planches du panneau mural à l'aide de 2 vis – en vous assurant que les colonnes demeurent bien verticales. **Les fenêtres s'ouvrent de l'intérieur, ne pas se tromper de sens lors de l'installation.**



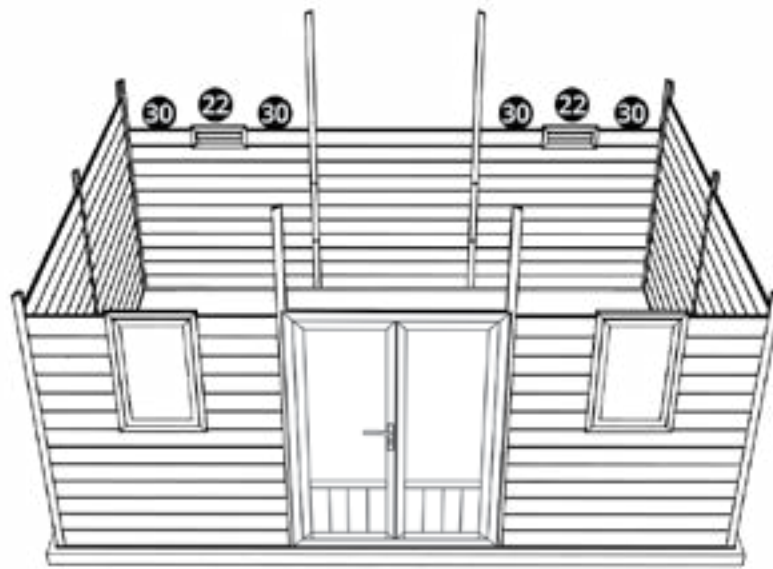

**EN** Put the vent kits upon the 10th board of the wall panel back side - put the short wall panel as per in the picture.

**FR** Mettez la grille de ventilation au dessus de la 10<sup>ème</sup> planche à l'arrière du cabanon. Entourez la ventilation avec les planches murales plus courtes comme présenté sur l'illustration.

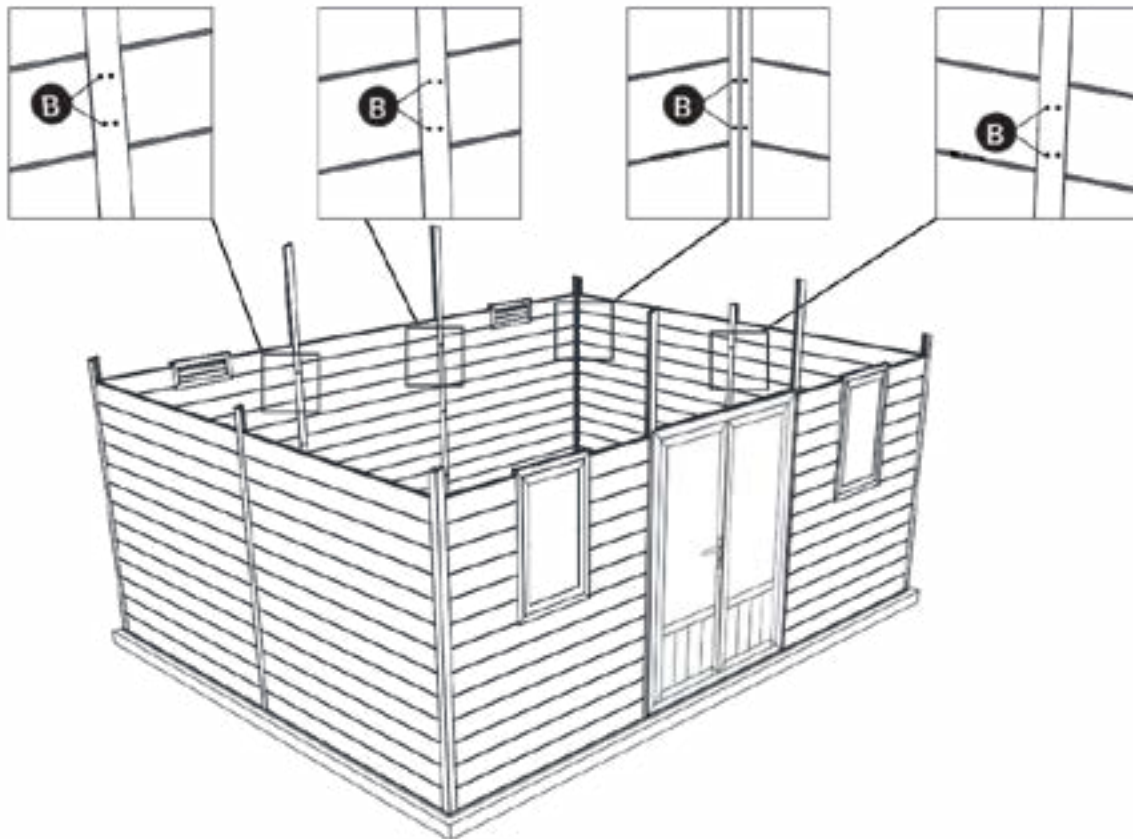

**EN** Continue the installation of the wall panels and note that the screws are required every 4 boards using 2 screws.

**FR** Continuez l'installation des lames murales en vissant toutes les 4 lames à l'aide de 2 vis.

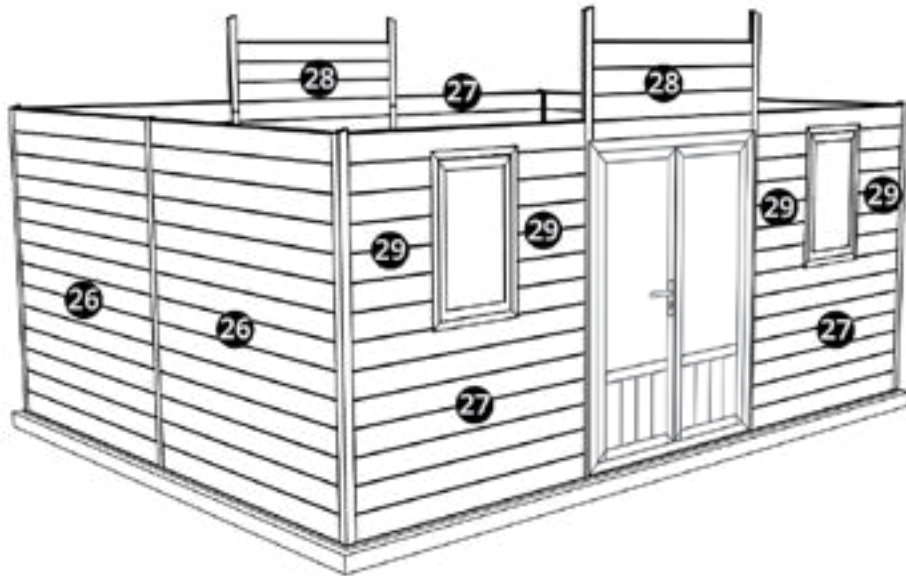

**EN** Complete the wall boards - make sure that you are using the right panels before installation.

**FR** Finalisez la pose des planches murales.

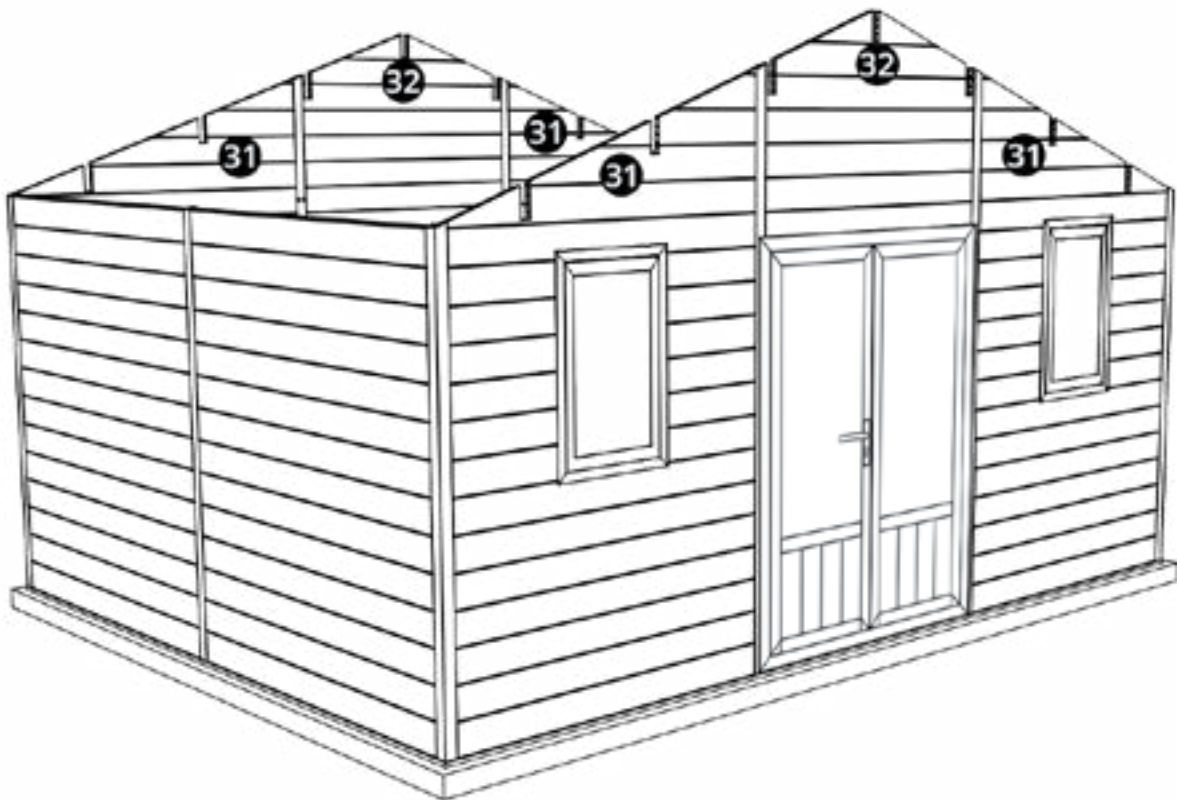

**EN** Put the right triangle panels into the right position.

**FR** Positionnez les panneaux muraux triangulaires.

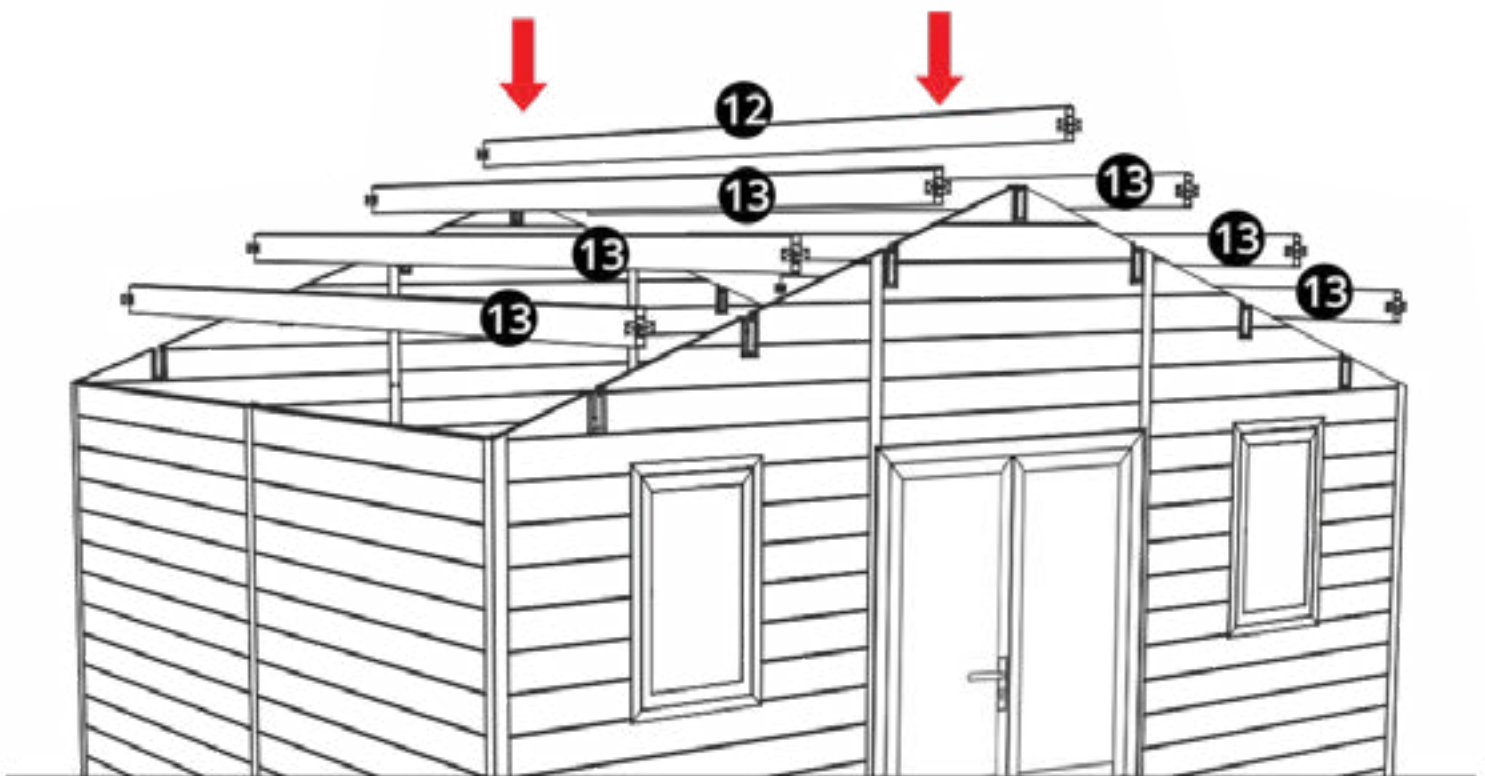
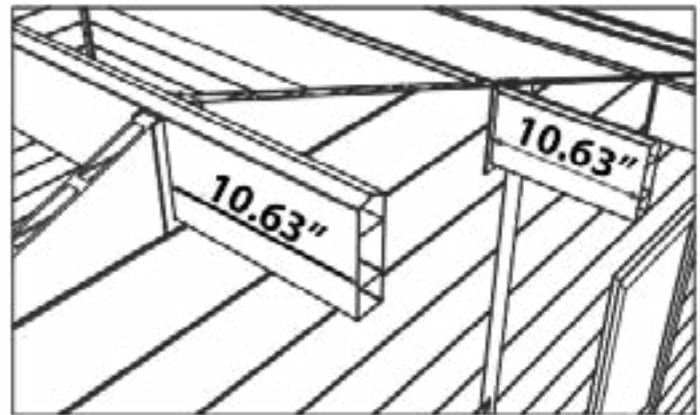
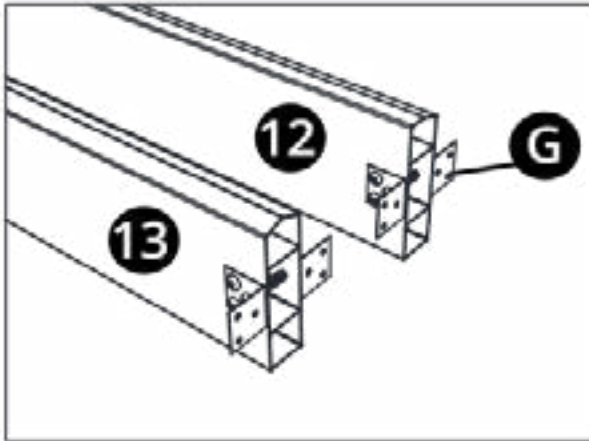

**EN** Slide in all the beams into the plugs and adjust the position of each beam. The beam should extend the front wall panel 10.63". Keep the extension dimension as acute as possible.

**FR** Insérez toutes les poutres dans les sere-poutres et ajustez la position de chaque poutre. Chaque poutre doit dépasser de 10.63", essayez de respecter autant que possible cette position.

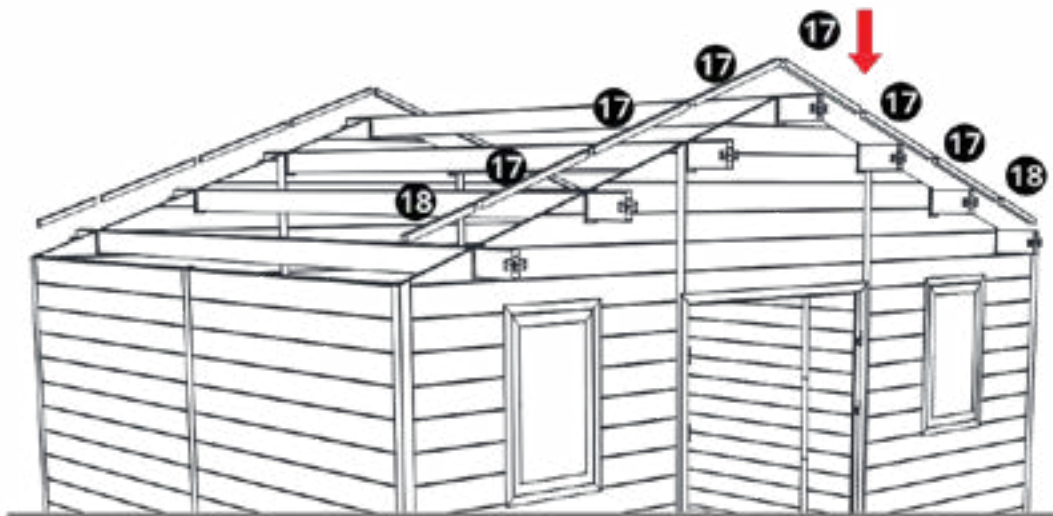

**EN** Cover the U profile to each unit of the wall panel between the beams.

**FR** Entre chaque poutre, recouvrir le panneau mural avec les profilés aluminium en forme de U.

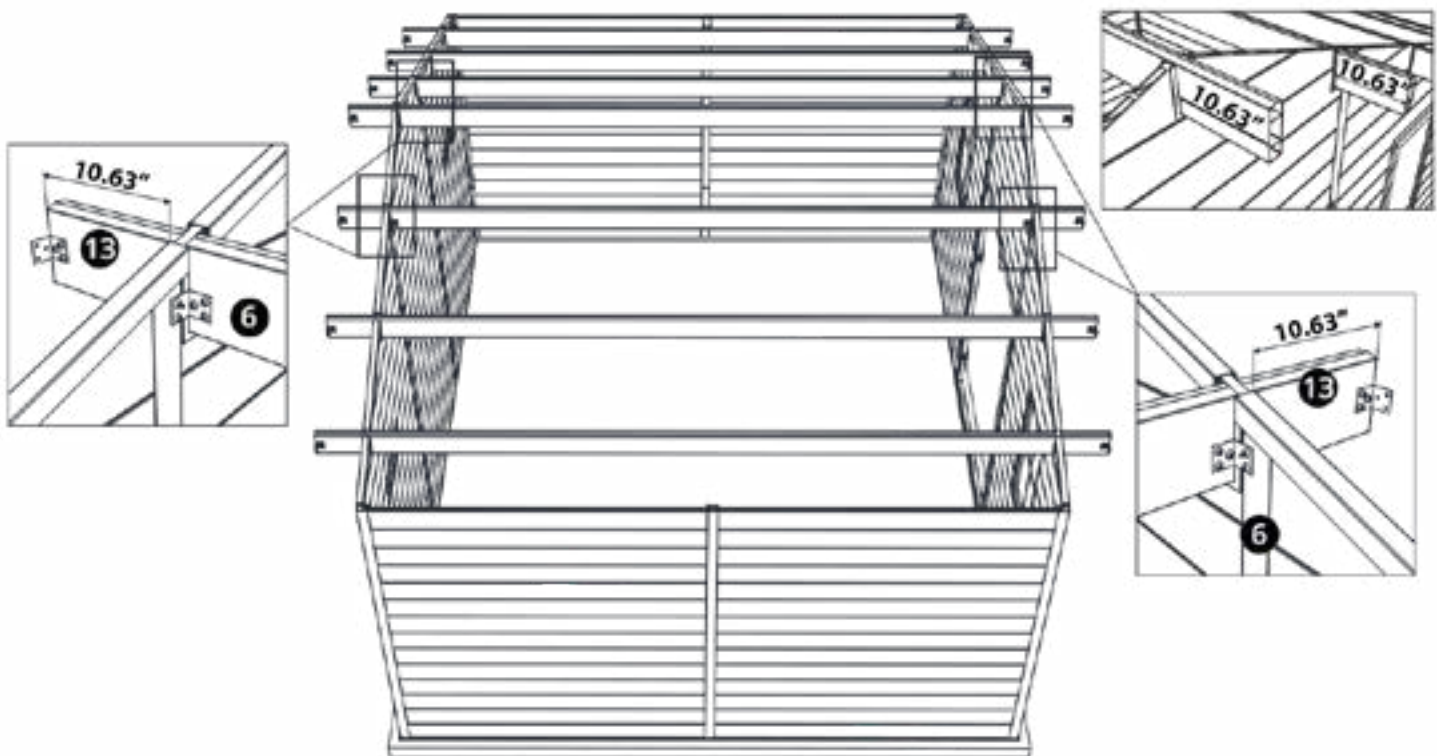

**EN** Attach the beams the L bracket connectors. Before screwing, make sure that the wall is standing straight and that the beams are not surpassing the 10.63" (front & back).

**FR** Fixez les poutres aux connecteurs du support en L. Avant de visser, assurez-vous que le mur est droit et que les poutres ne dépassent pas les 10.63" (avant et arrière).

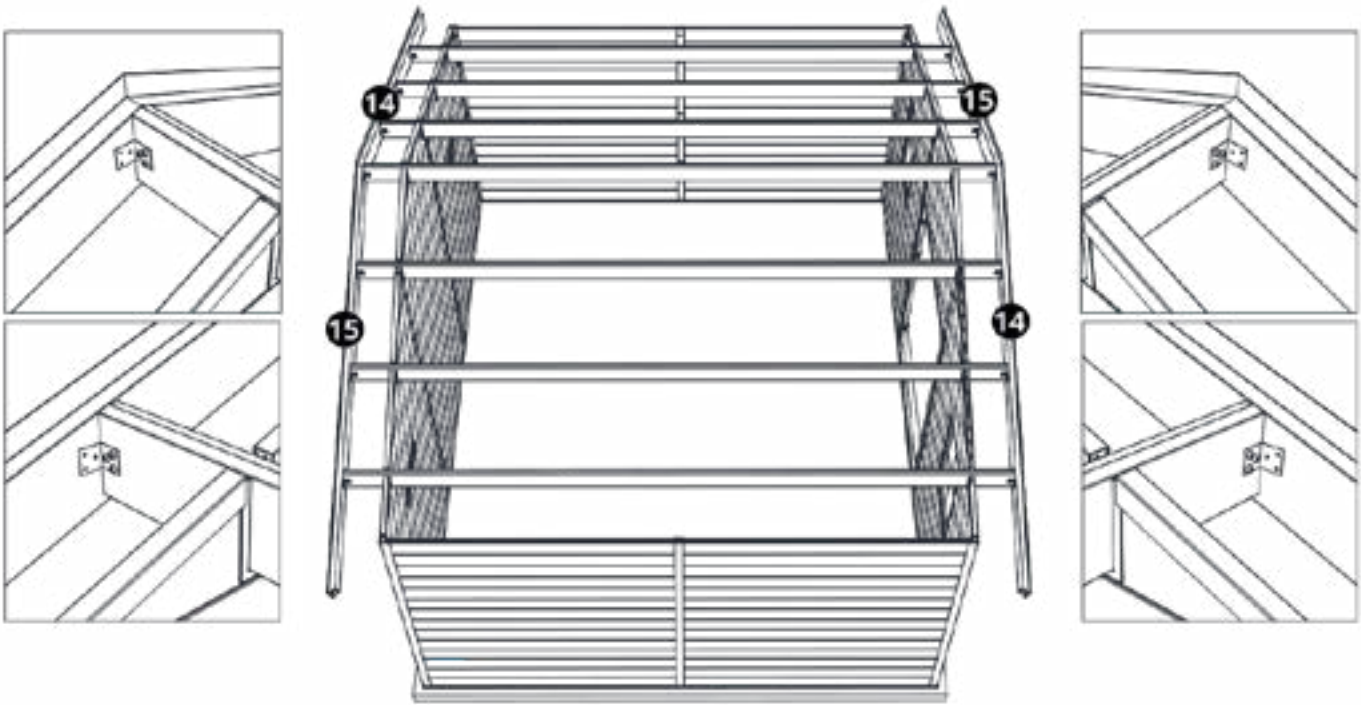

**EN** Screw the front outer roof frames to the beams and back with the beam connectors.

**FR** Vissez aux poutres les cadres extérieurs de toit avant et arrière grâce aux connecteurs de poutre.

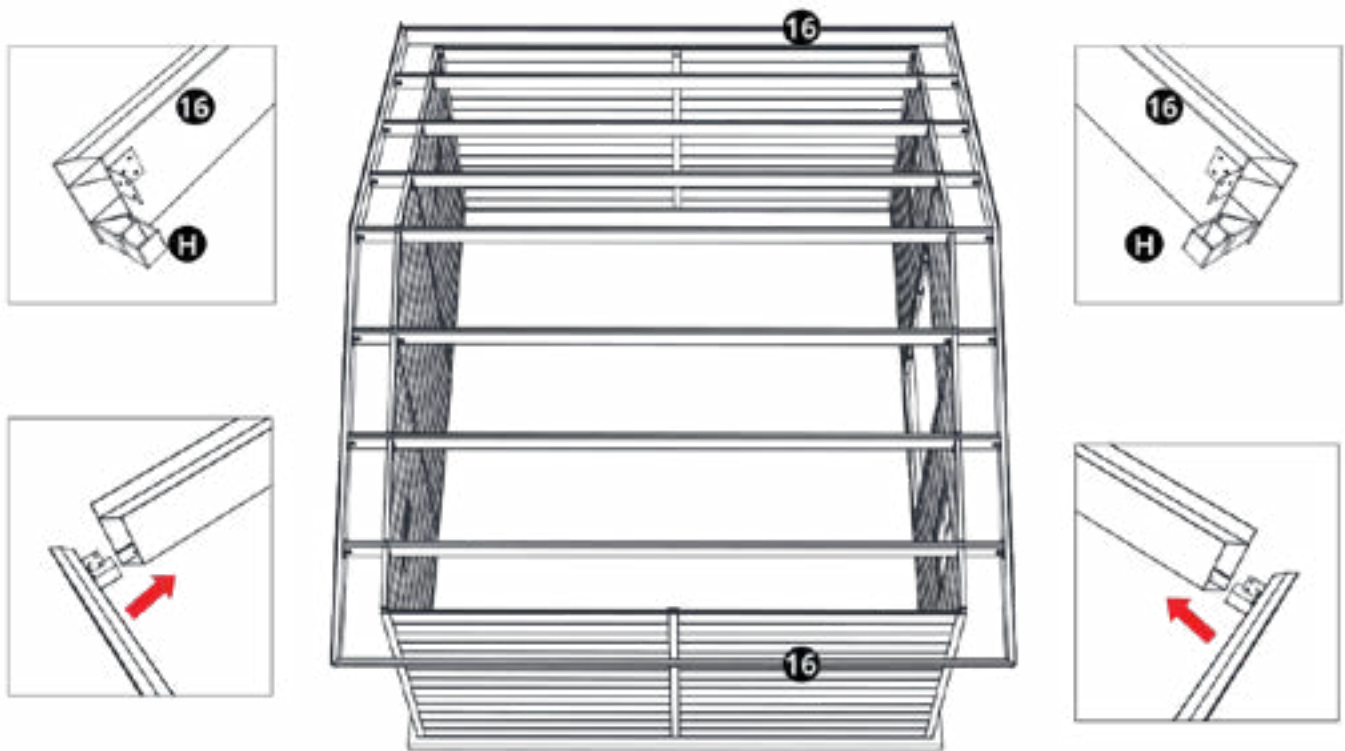

**EN** Attach the L bracket connectors to the right and left outer roof frames and position them as shown in the picture above.

**FR** Fixez les connecteurs de cadre de toit en L aux cadres extérieurs de toit droite et gauche et positionnez-les comme illustré.

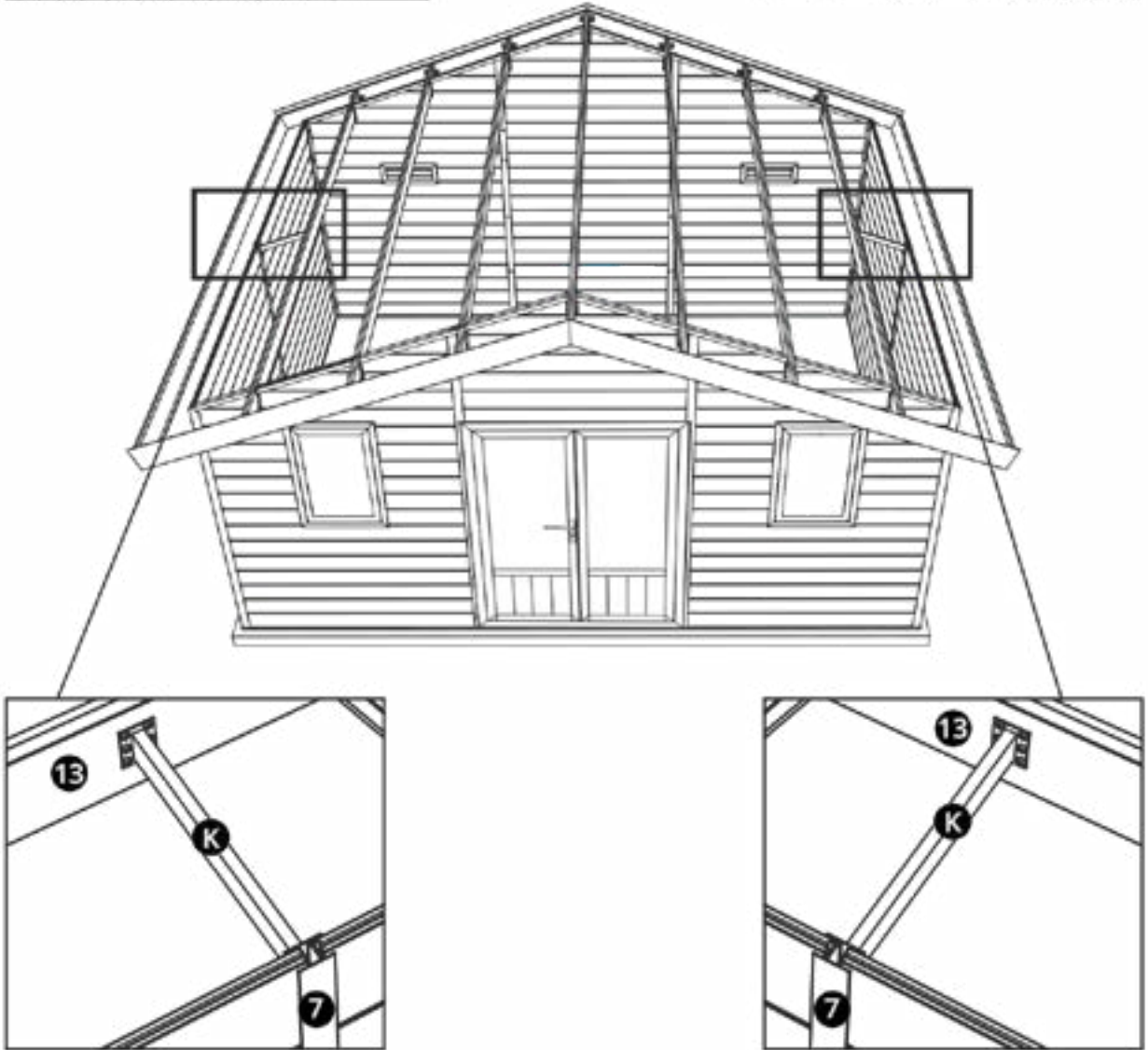
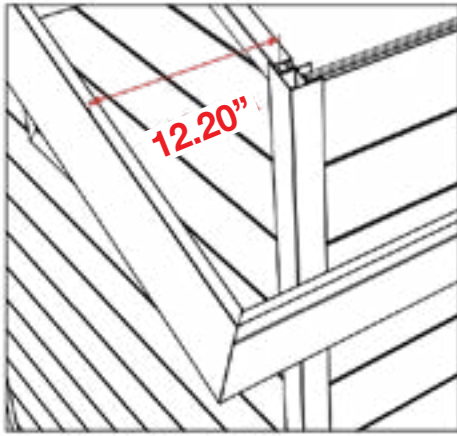

**EN** Check the distance between the outer side roof frames and the wall panel and adjust if necessary. This should be 12.20". Fasten the support bar between the beam and the column with screws.

**FR** Vérifiez la distance entre les cadres extérieurs de toit latéraux et le panneau mural et ajustez si nécessaire. Celle-ci doit être de 12.20". Fixez à l'aide de vis, les rails de connexion entre la poutre et la colonne.

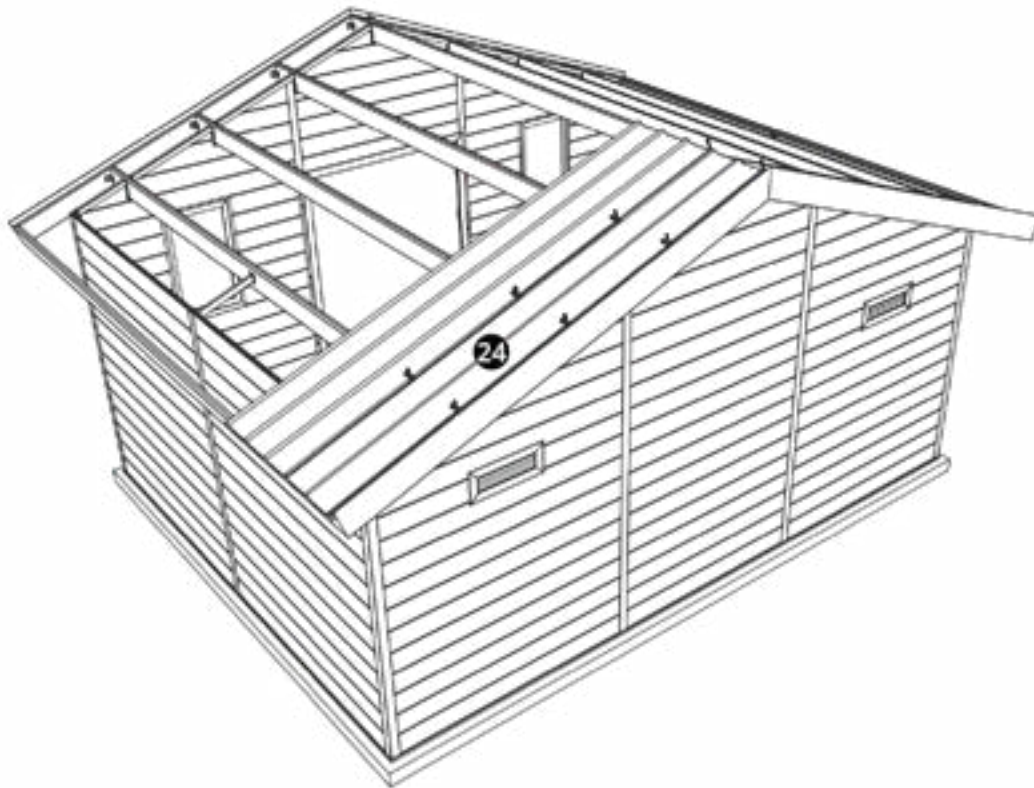

**EN** Position the first roof panel (gray side out) on the beams. Make sure the top of the roof panel is close to the center beam to place a screw. Screw the panel on each beam, except for the exterior side roof frame. Leave a 0.39" space between the roof panel and the outer front and rear side roof frame.

**FR** Positionnez le premier panneau de toit (face grise à l'extérieur) sur les poutres. Assurez-vous que le sommet du panneau de toit soit proche de la poutre centrale afin d'y placer une vis. Vissez le panneau sur chacune des poutres, à l'exception du cadre de toit latéral extérieur. Laissez un espace de 0.39" entre le panneau de toit et le cadre de toit extérieur frontal et arrière.

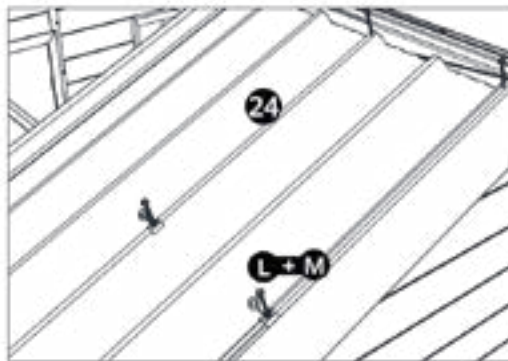
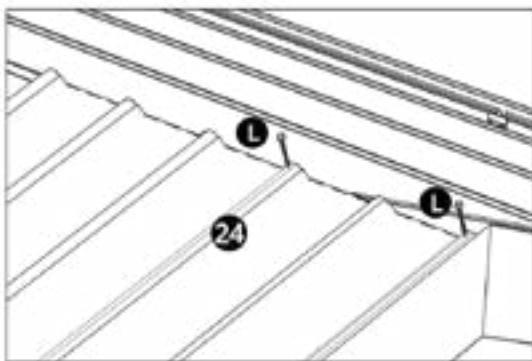

**EN NOTE:**

1. Do not place the water-proof protection on the center beam screws.
2. Manually support the roof panel until a minimum of 2 screws are attached.
3. Make sure that the screw goes through the roof. One row of screws is required every two corrugations.

**FR NOTE:**

1. Ne placez pas les protections anti-pluie sur les vis de la poutre centrale.
2. Soutenez manuellement le panneau de toit jusqu'à fixation de 2 vis minimum.
3. Assurez-vous que les vis traversent bien la toiture. Une rangée de vis est nécessaire toutes les deux ondulations.

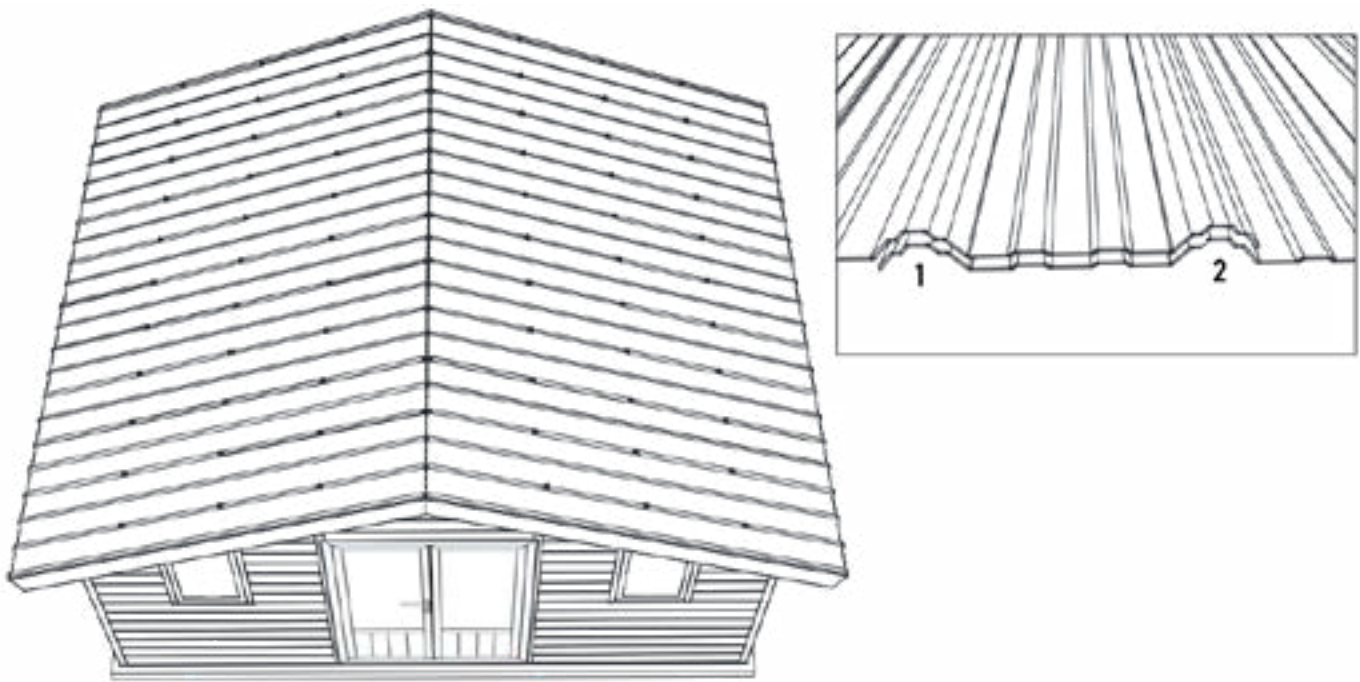

**EN** One by one, install the other panels on the roof. The panels should always overlap two corrugations from the previous ones.

**FR** Un par un, installez les autres panneaux de toit. Le panneau de toit suivant doit toujours recouvrir deux ondulations du panneau de toit précédent.

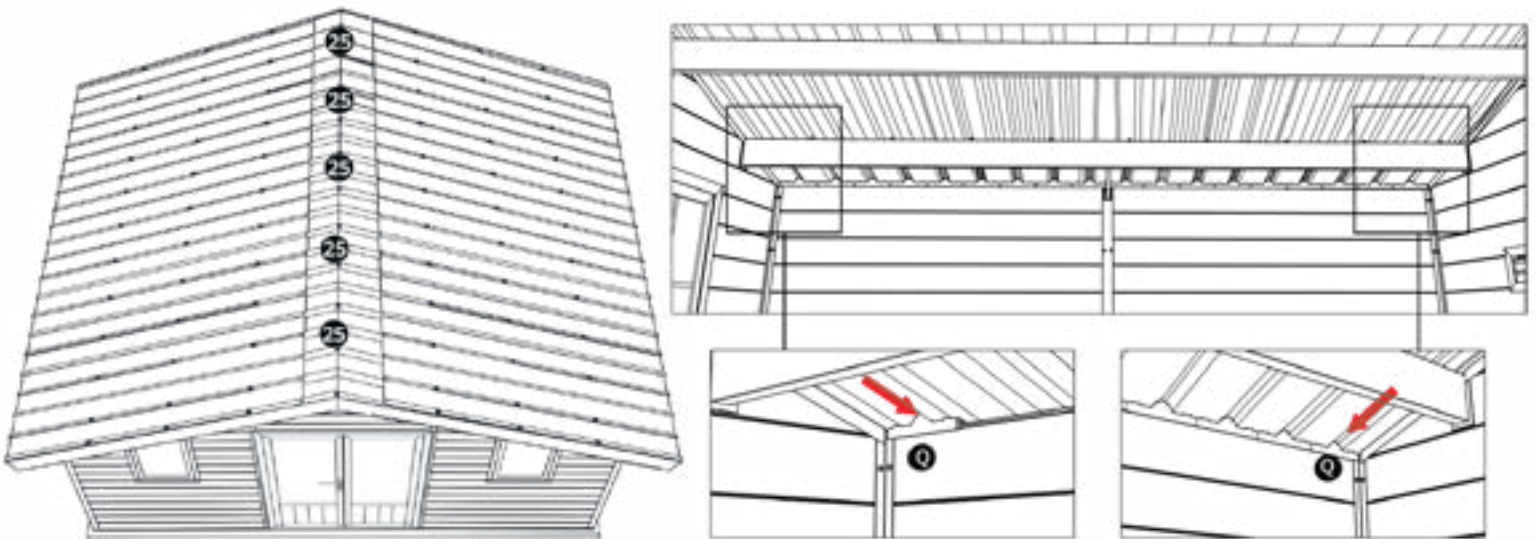

**EN** Attach the ridges one by one using the roof fixing kit.

**FR** Fixez les faîtières une à une grâce au kit de fixation de toit.

**EN** Insert, one after the other, the roof plug between the roof panel and the wall panel.

**FR** Insérez, les uns après les autres, les bouchons de toit entre panneau de toit et planche murale.



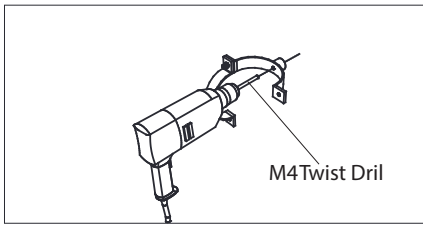

M4Twist Drill

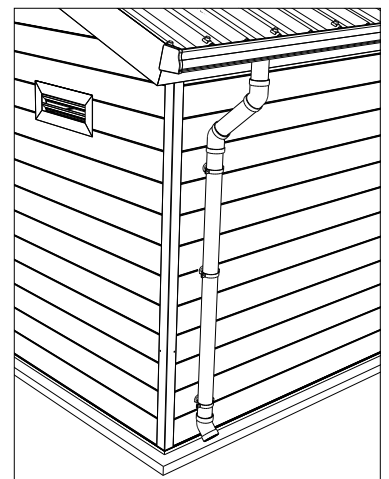
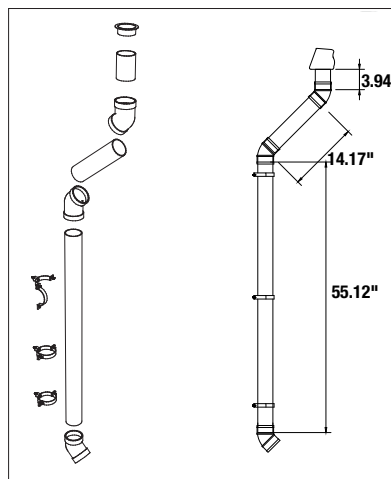
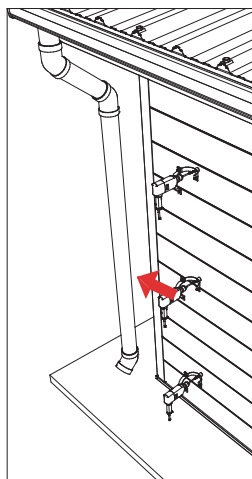
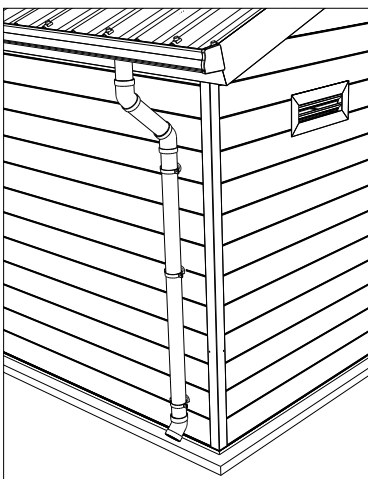
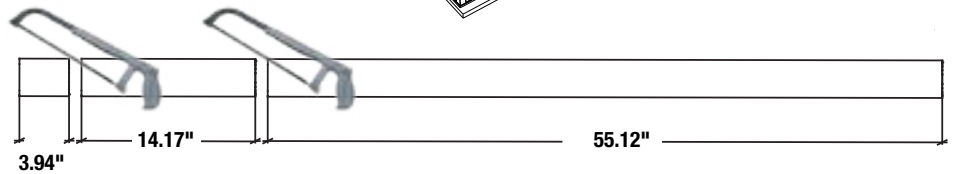
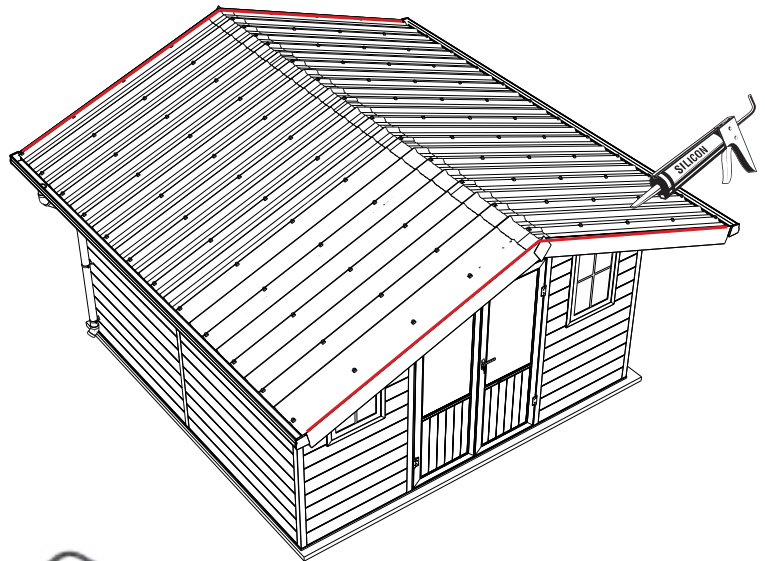
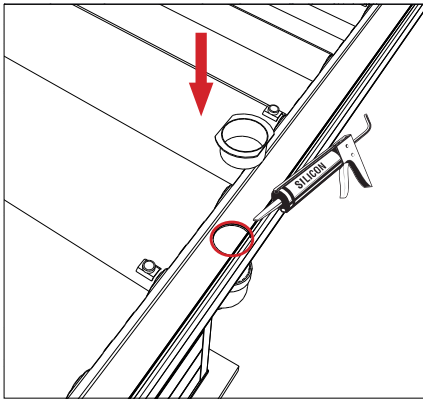

**EN** Use a saw to cut the drain pipe into 3 pieces according to the length shown above. Before attaching the connection clamps, place the 3 pieces of cut drain pipe and elbows as shown in the picture above, then determine the position of the screws that will be used to anchor the connection clamps to the wall, and drill the holes. Next, remove the drain pipe and elbows, and attach the connection clamps to the wall with screws. Replace the downpipe and elbows and secure them with the connection clamps. Finally, use sealant to seal the gutter outlet.

**FR** À l'aide d'une scie, coupez le tuyau de descente de gouttières en 3 parties en respectant la longueur indiquée ci-dessus. Avant de fixer les colliers de connexion, placez les 3 parties de la descente coupée et les coudes comme sur la photo ci-dessus, puis établissez la position des vis qui serviront à ancrer les colliers de connexion sur le mur, et percez les trous. Ensuite, retirez la descente et les coudes, puis fixez les colliers de connexions au mur à l'aide de vis. Remettez le tuyau de descente et les coudes en place et fixez-les avec les colliers de connexions. Enfin, utilisez le mastic pour sceller la sortie de la gouttière.

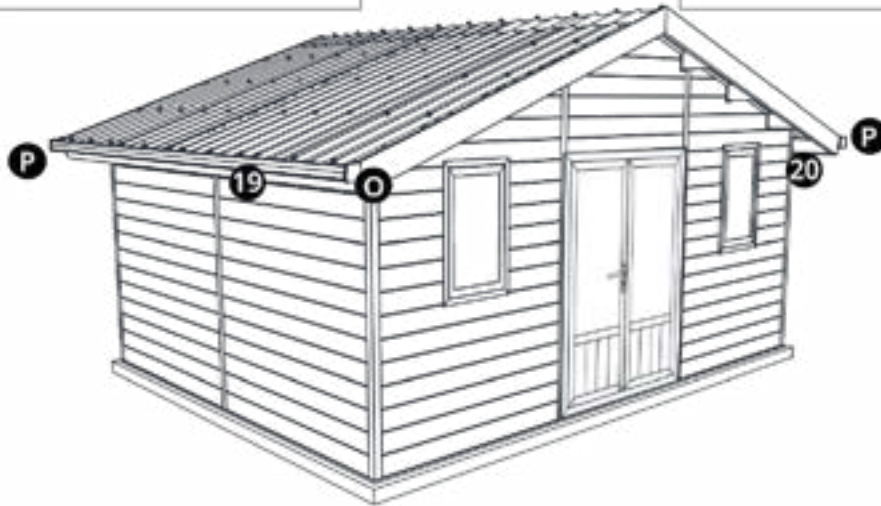
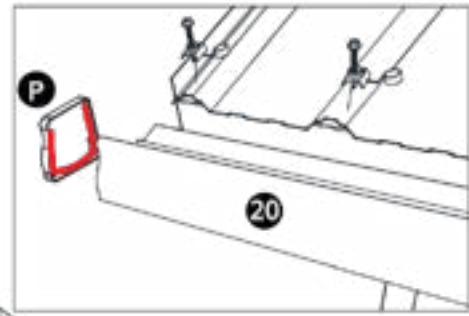
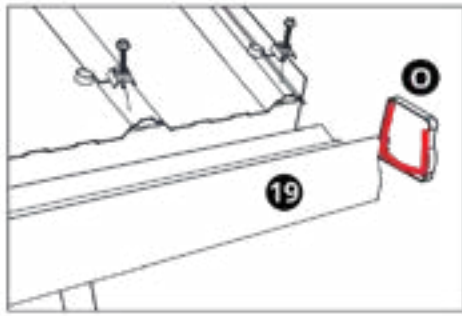

**EN** Position the gutters and insert the corner into the spacing between the roof panel and the exterior roof frame. Place the last row of screws on the exterior side of the roof frame into the panels. Position the gutter end and seal with glue using the caulking gun around the cover.

**FR** Positionnez les gouttières et insérez le coin dans l'espace entre le panneau de toit et le cadre extérieur de toit. Placez dans les panneaux la dernière rangée de vis sur le cadre de toit latéral extérieur. Positionnez les embouts de gouttière à l'aide de colle.

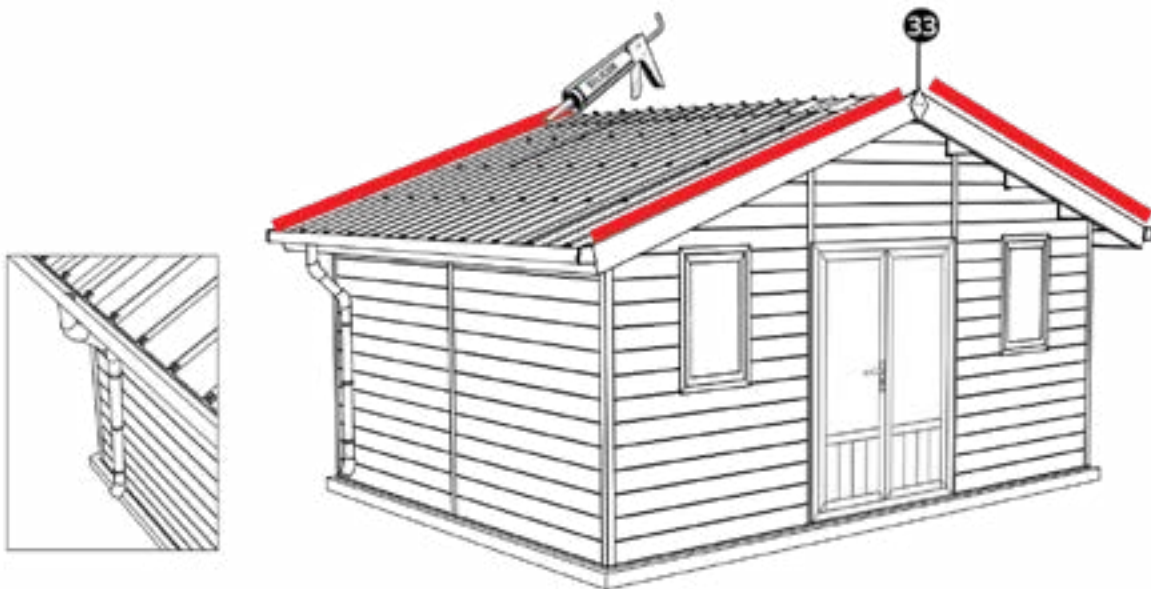

**EN** Install the gutter downspouts 2.95". Using the caulking gun, create a joint between the roof panel and the front and rear outer roof frame.

**FR** Installez la descente de gouttière 2.95". A l'aide d'un pistolet, créez un joint entre le panneau de toit et le cadre de toit extérieur frontal et arrière.

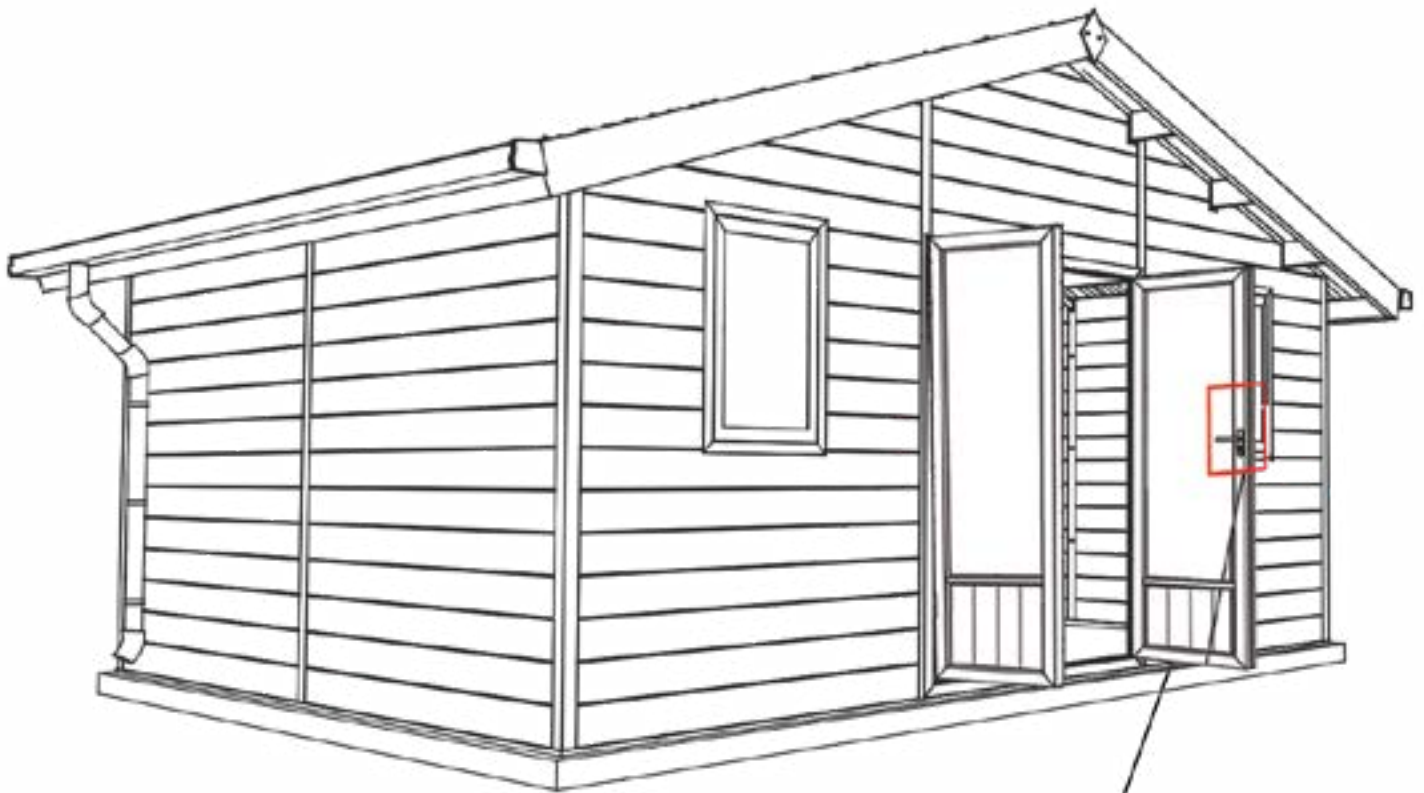

**EN** Now install the doors - Fit the double door using the hinges. Test the opening/closing of the door and adjust if necessary. As soon as the positioning is convenient for you, screw the door frame to the back of the wall panel.

**FR** Emboitez la double porte à l'aide des charnières. Testez l'ouverture/fermeture de la porte et ajustez si besoin. Dès que le positionnement vous convient, vissez à l'arrière du panneau mural le cadre de porte.

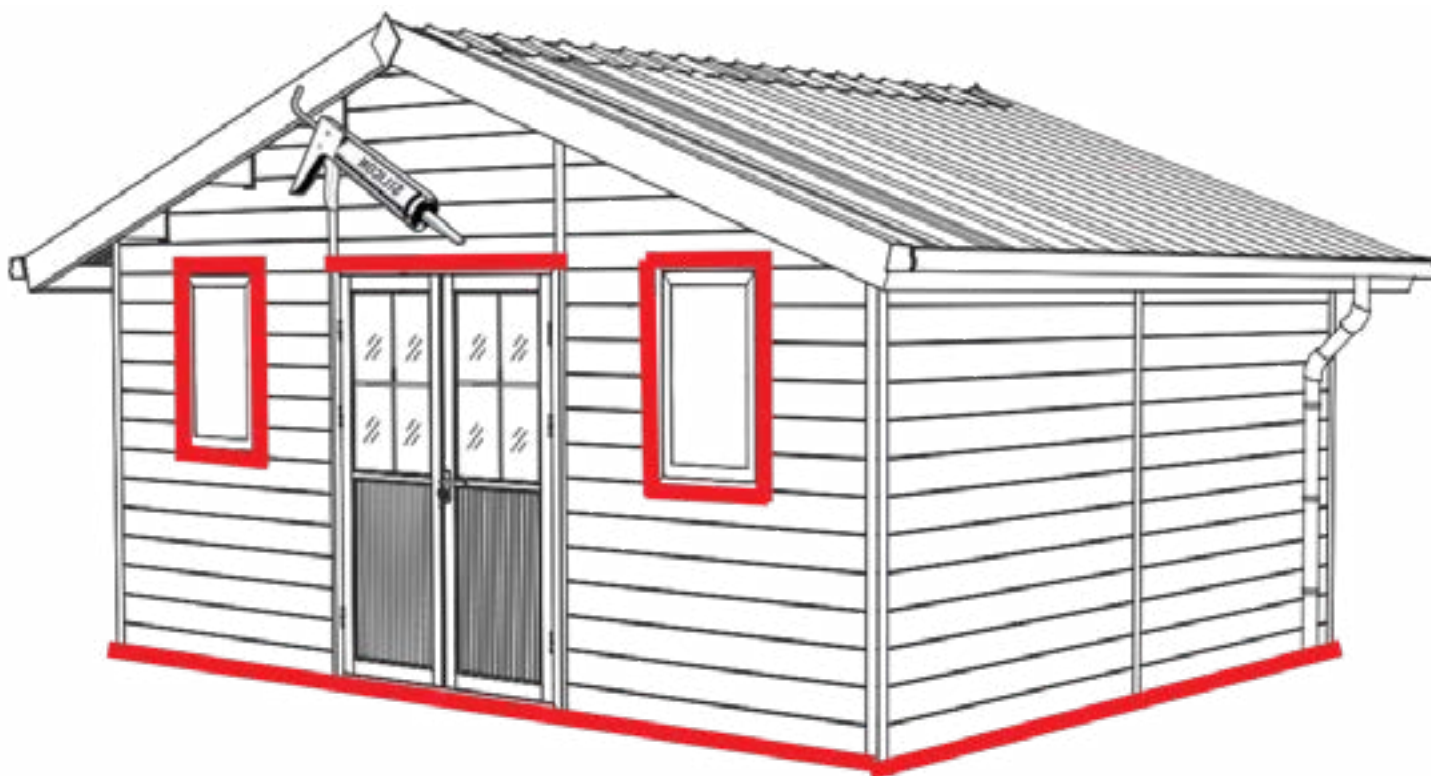

---

**EN** With the help of the caulking gun, create a seal at the base, around the windows and the doors to insulate from rain (as shown in red).

---

**FR** A l'aide d'un pistolet, créez un joint à la base, autour des fenêtres et de la porte afin d'isoler de la pluie (comme illustré en rouge).

# IMPORTANT

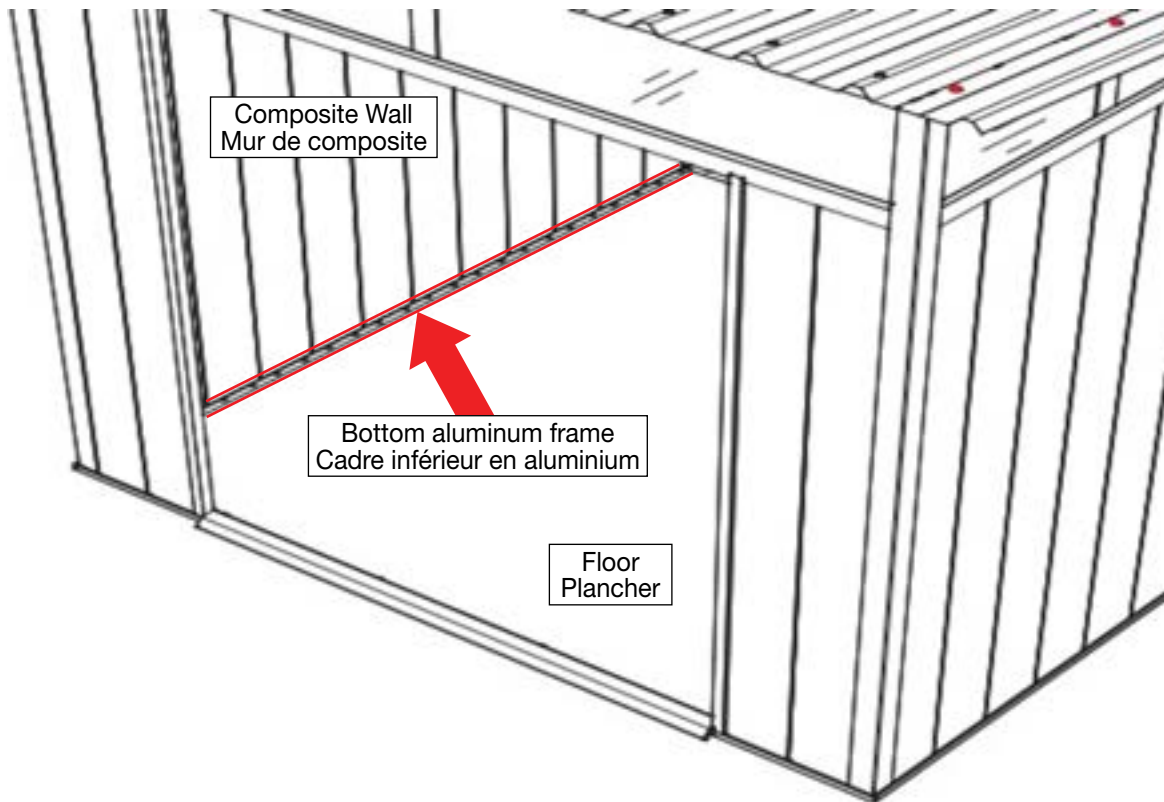

**EN** To prevent water infiltration issues, you must add a sealant at the bottom of the shed:

1. Perform a thorough cleaning of the shed: remove any dust and debris from the floor and ensure the floor is completely dry.
2. Apply a bead of sealant all around the interior of the shed between the floor and the lower aluminum frame (refer to page #11 in the installation guide).
3. Apply a bead of sealant all around the interior of the shed between the composite wall and the lower aluminum frame as well.
4. Apply a sealant from the floor upwards with a minimum of 4 inches in all corners.

It is recommended to use a sealant of the Flextra type (thermoplastic rubber-based).

**FR** Afin d'éviter les problèmes d'infiltration d'eau, vous devez ajouter un scellant dans le bas du cabanon :

1. Effectuez le nettoyage complet du cabanon : enlevez toute la poussière et les débris qu'il pourrait y avoir sur plancher, et s'assurer que le plancher soit complètement sec.
2. Faire un joint de scellant tout le tour à l'intérieur du cabanon entre le plancher (sol) et le cadre inférieur en aluminium (référez-vous à la page #11 du guide d'installation).
3. Effectuez également un joint de scellant tout le tour à l'intérieur du cabanon entre le mur en composite et le cadre inférieur en aluminium.
4. Effectuez un joint du plancher vers le haut avec un minimum de 4 pouces dans tous les coins.

Il est recommandé d'utiliser un scellant de type Flextra (thermoplastique à base de caoutchouc).



# WARRANTY - GARANTIE



Scan the QR code to find out about all your shed's warranty in the **SUPPORT** section on the Fiberwood website.



Scannez le code QR pour découvrir tous les détails concernant la garantie de votre cabanon dans la section **SUPPORT** sur le site de Fiberwood.

*For any problem with your shed, please contact us directly at: Toll Free : 888-360-1866*

*Pour tout problème avec votre cabanon, veuillez nous contacter directement au : Sans frais : 888-360-1866*

829, boul. Industriel, Bois-des-Filion, QC, J6Z 4T3 – [info@fiberwood.ca](mailto:info@fiberwood.ca)





829, Industriel Blvd, Bois-des-Filion, Quebec, Canada, J6Z 4T3  
514-360-1866 / 888-360-1866  
[fiberwood.ca](http://fiberwood.ca)

**FOR ANY PROBLEM WITH YOUR SHED PLEASE CONTACT US DIRECTLY  
POUR TOUT PROBLÈME AVEC VOTRE CABANON, VEUILLEZ NOUS CONTACTER DIRECTEMENT**